

A	B	C	D
1	S383-0022	1284	534 3/3
2	S383-0023	606	534 3/3
3	S383-1037	1904	385 1/3
4	S383-1038	1904	385 1/3
5	S383-1039	1517	350 3/3
6	S383-2025	780	780 2/3
7	S383-2026	780	780 2/3
8	S383-3016	749	764,5 2/3
9	S383-3017	310	349 2/3
10	S383-3018	309	349 2/3
11	S383-4009	1904	764,5 1/3
12	S383-9012	1929	775 1/3
13	dr-418	418	22 2/3

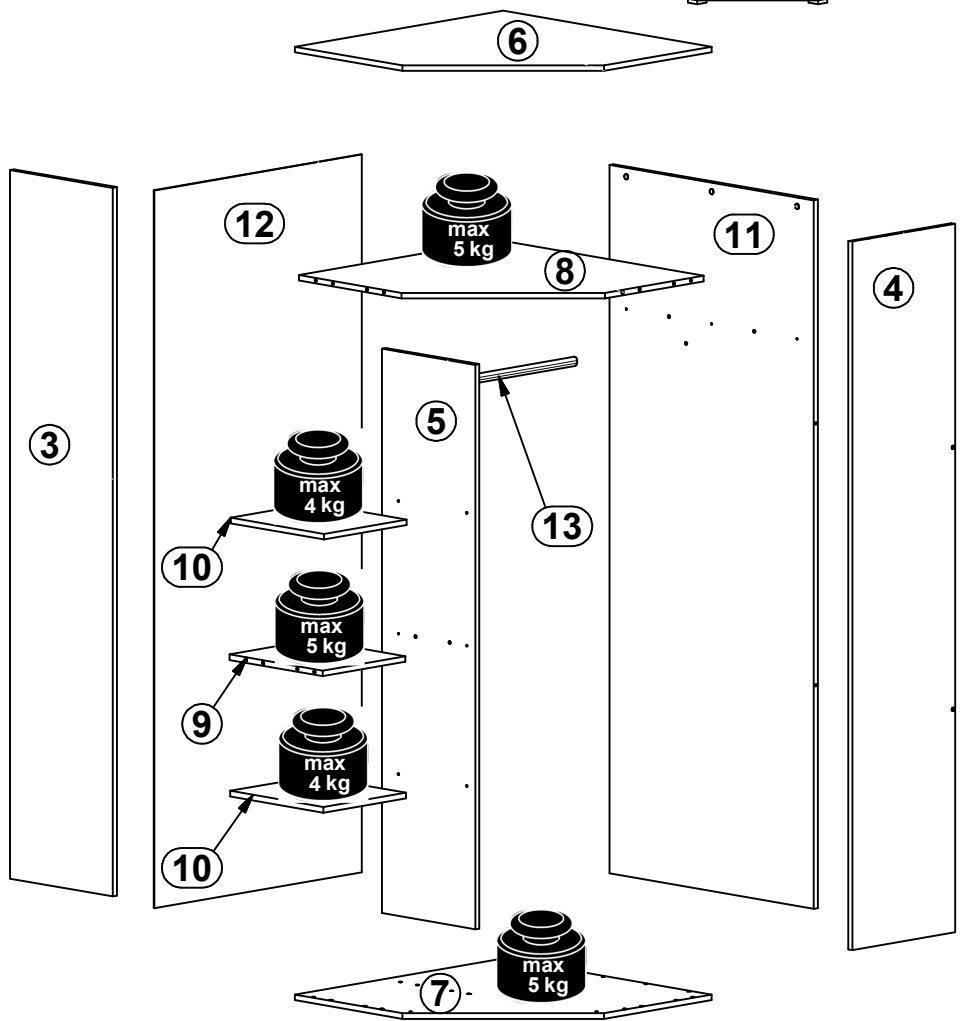

5x 45° a32	5x b31	1x 128mm c409	8x Ø5x17 mm d1	11x Ø7x50 mm e1	10x Ø6x13 mm e3	26x Ø8x30 mm f1	5x Ø51 mm k82/1	5x 58x58/18 mm k82/2
80x 1.4x20 mm l1	2x h=22mm n1	1x n76	1x silikon o21	2x Ø3,5x13 mm p1	1x Ø6,3x15 mm d5	10x Ø3,5x15 mm p51	6x Ø4x13 mm p93	20x Ø15x12 mm #16 r1
20x 20/11 r42	2x s1	16x Ø16 s2	1x 4 mm z1	1x n26	1x Ø3,5x16 mm p38			

1 

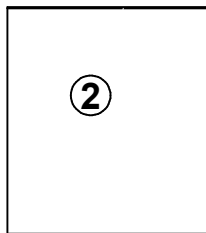
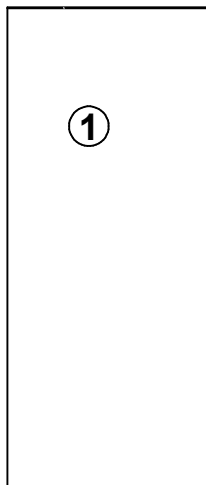
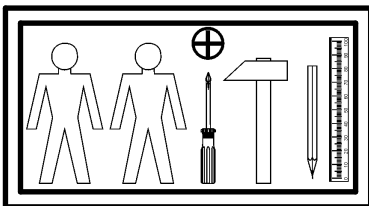
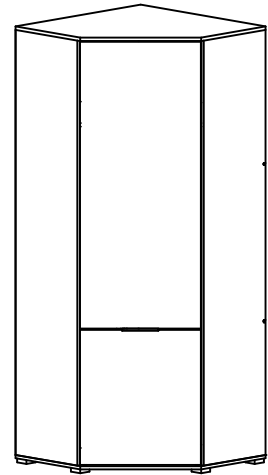
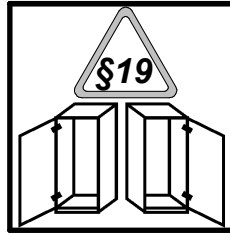
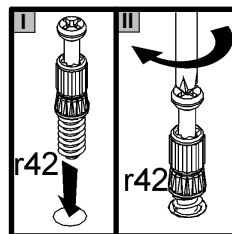
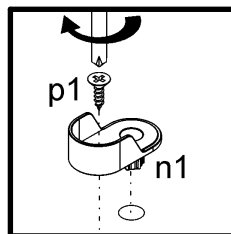
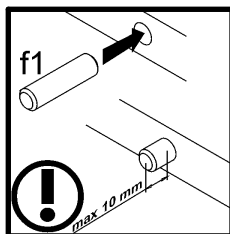
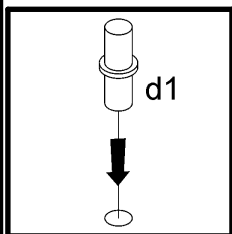
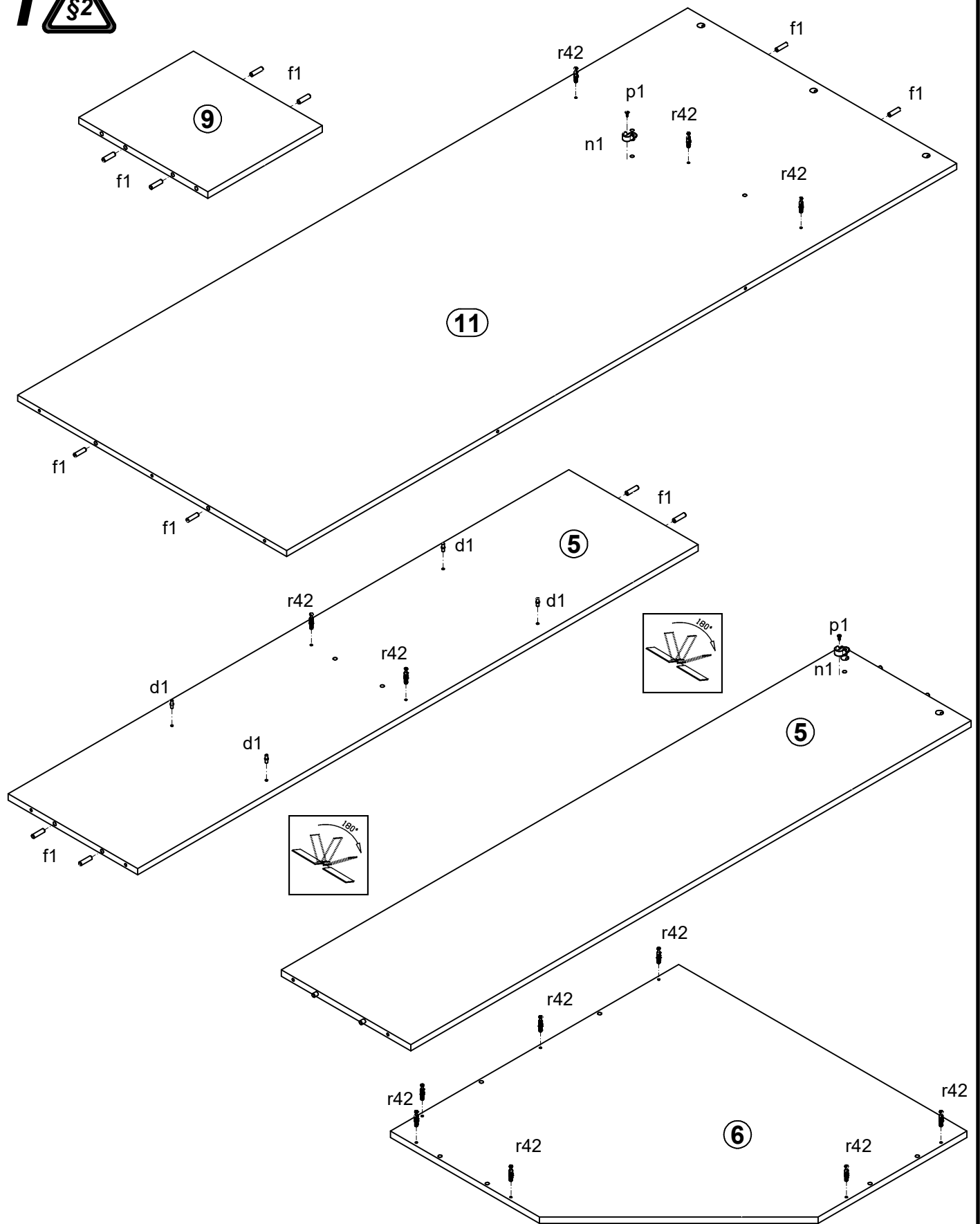

2

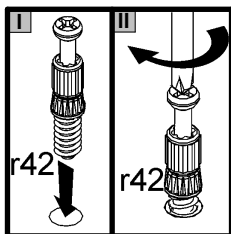
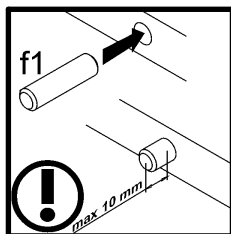
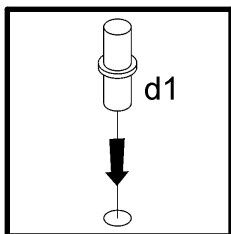
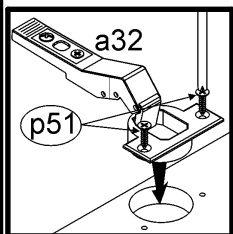
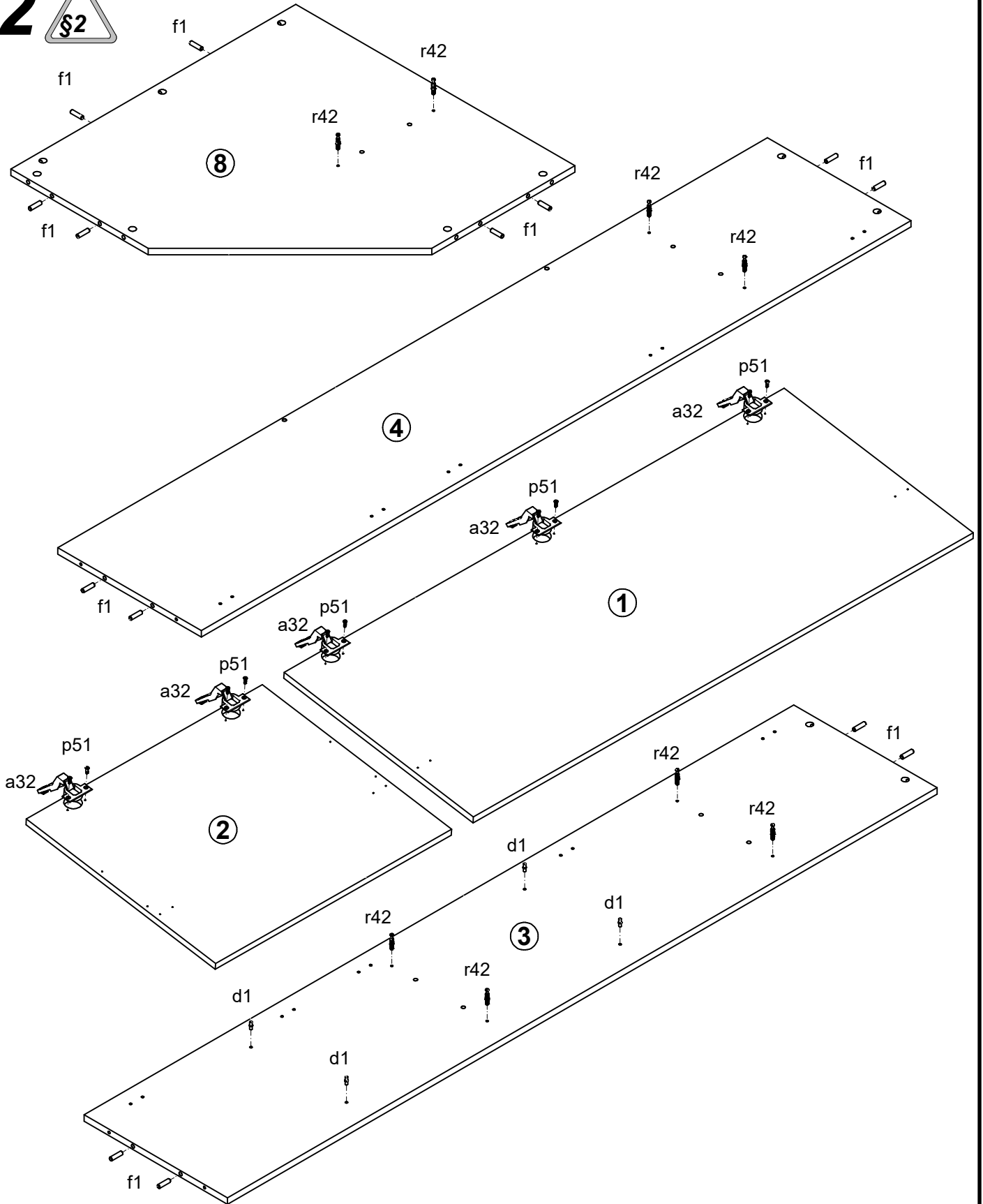

3

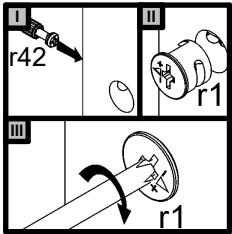
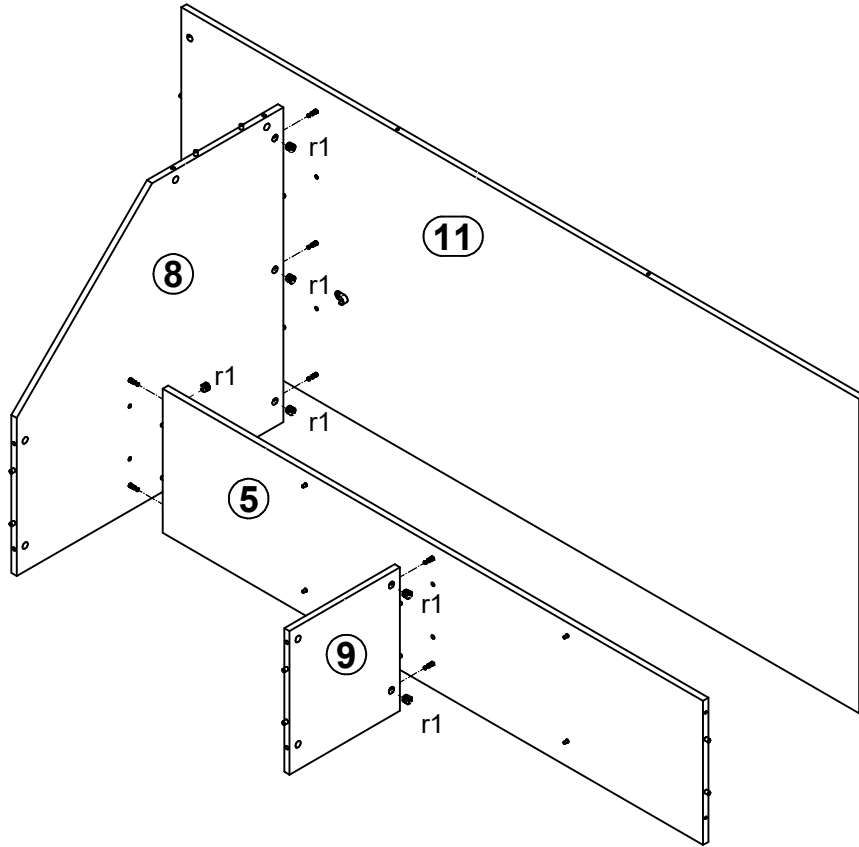

4

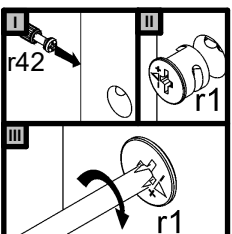
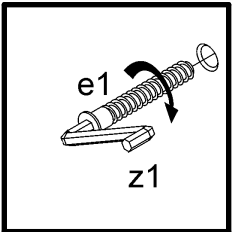
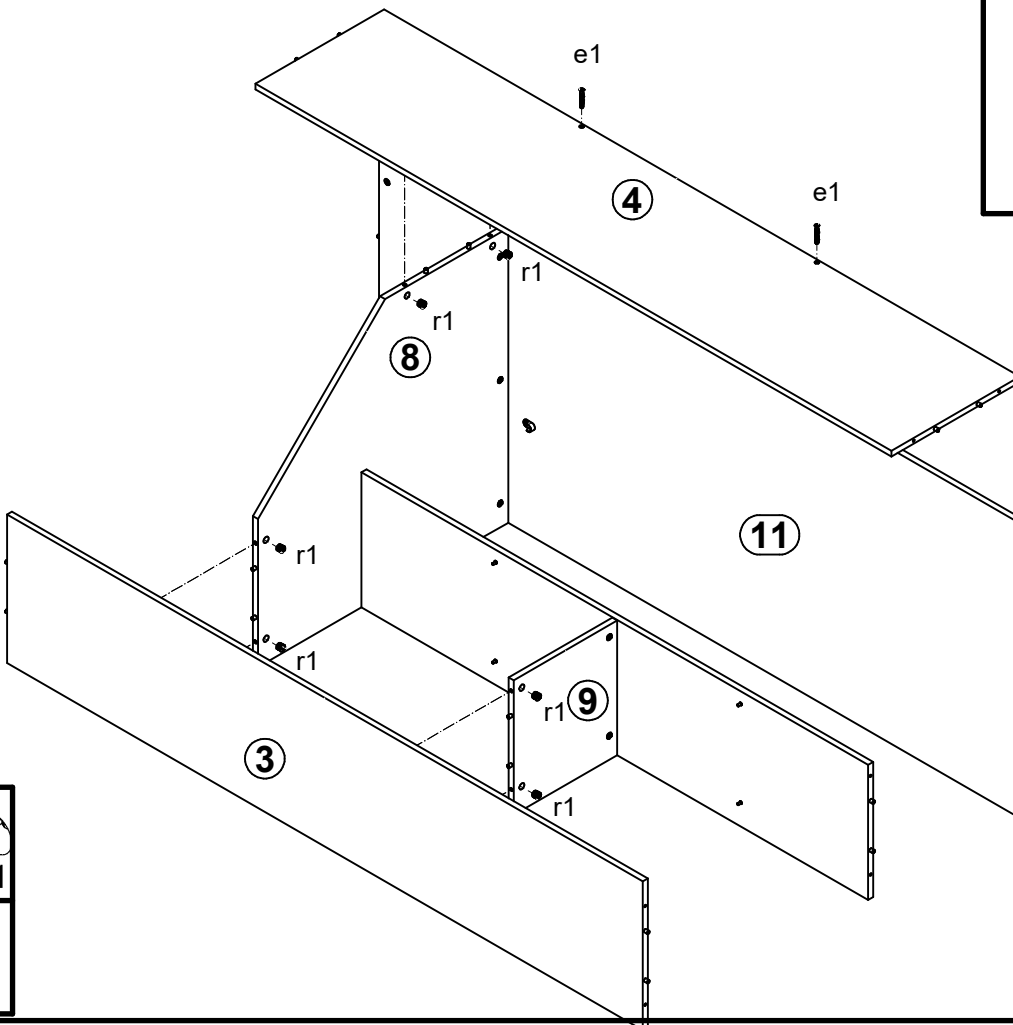

5

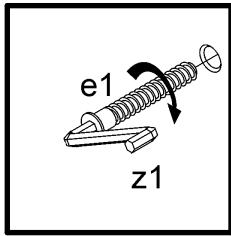
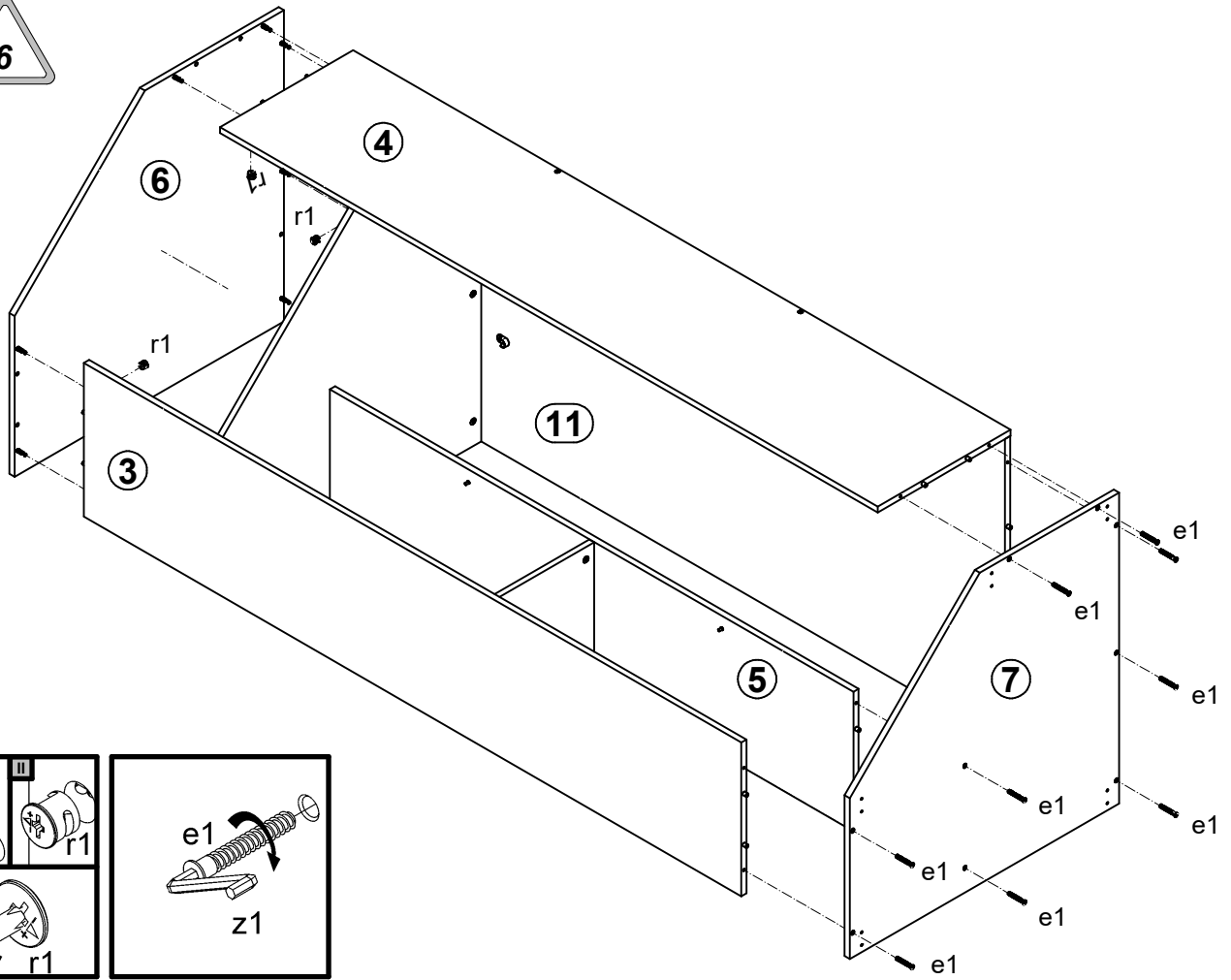

6

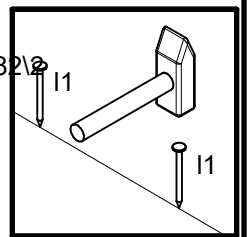
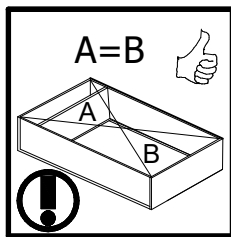
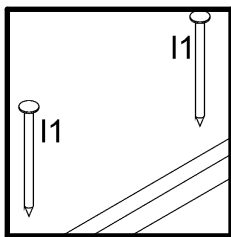
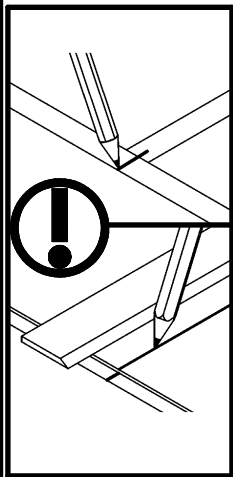
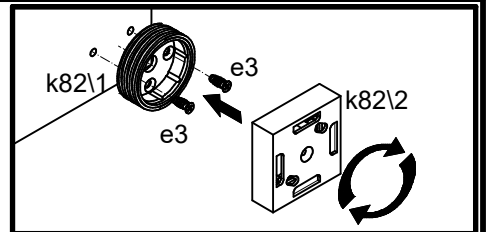
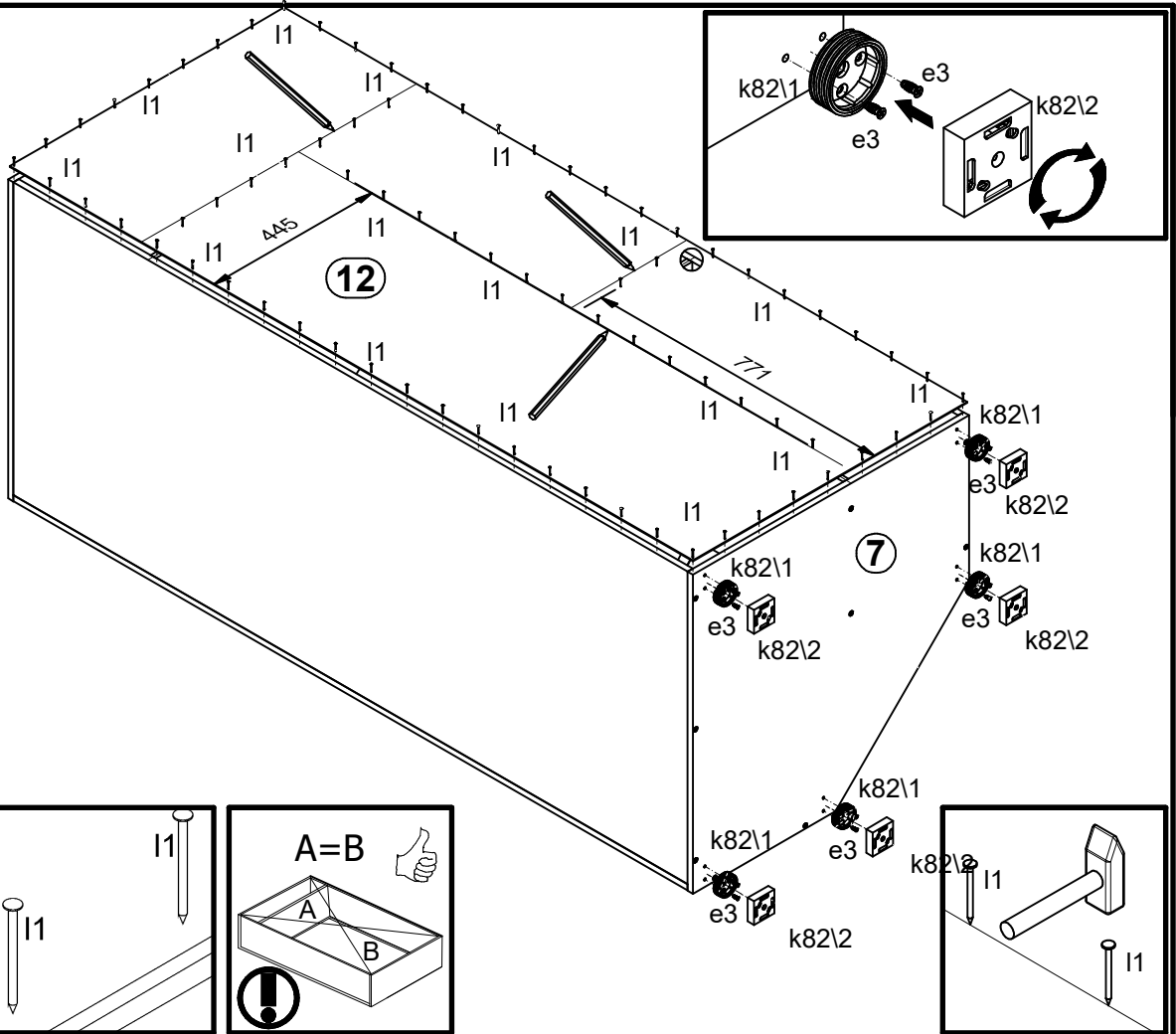

7A

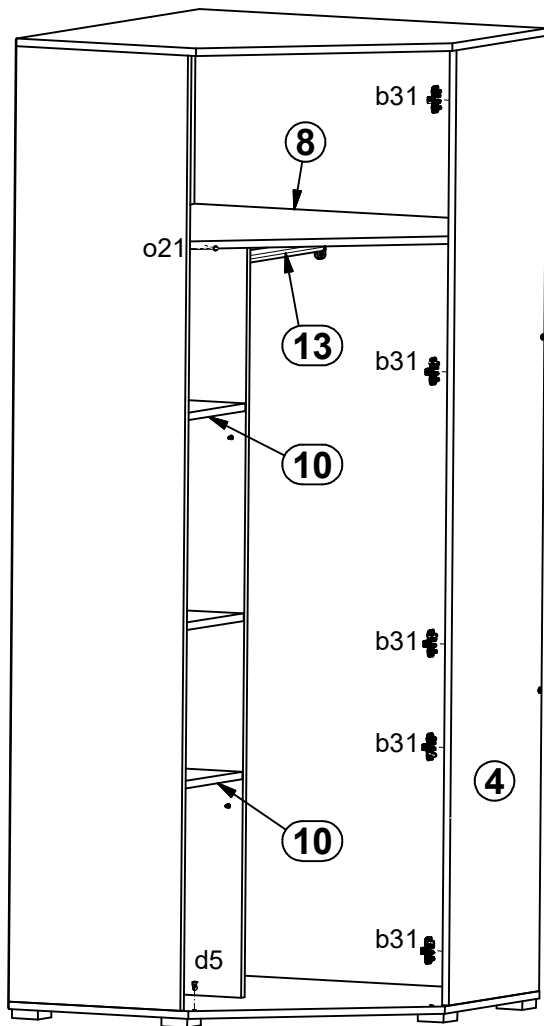

7B

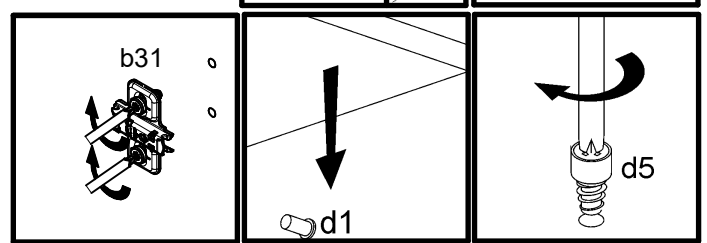
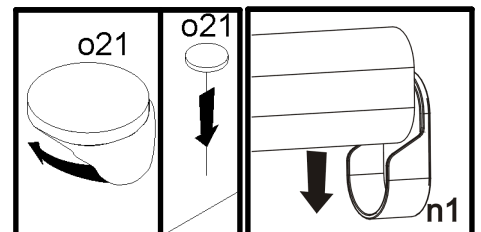
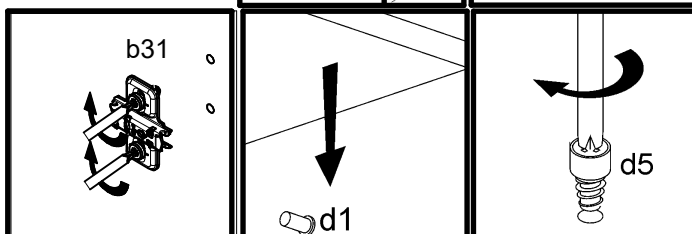
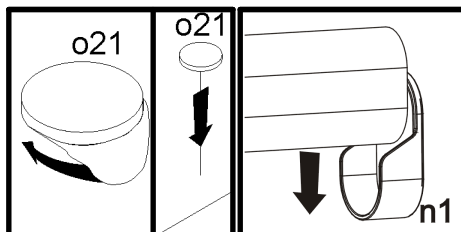
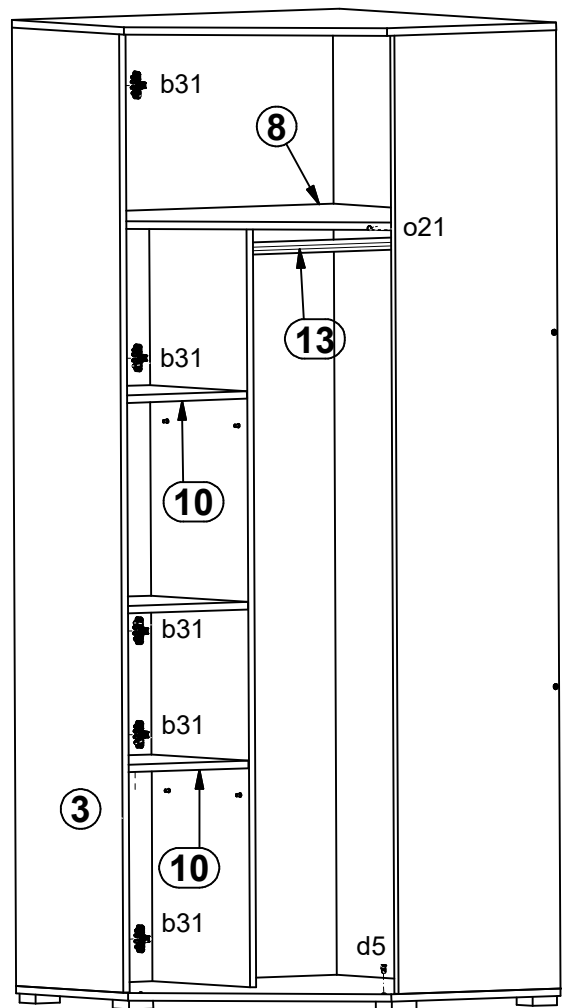

8A

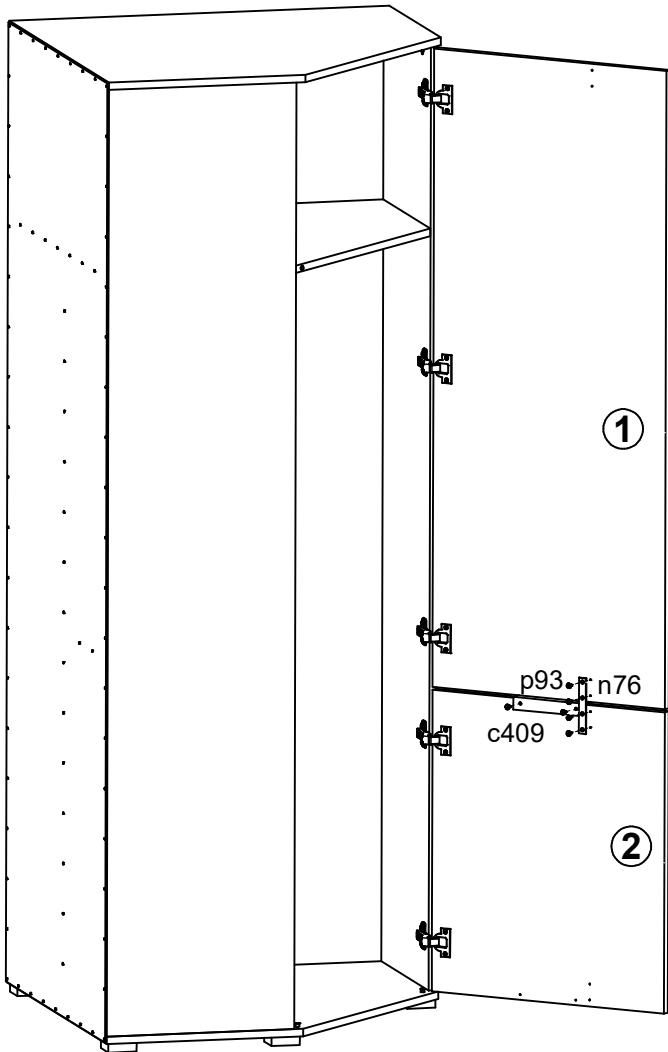

8B

