

A	B	C	D
1	S383-0010	606	555 1/2
2	S383-0011	1284	555 1/2
3	S383-1007	1904	385 1/2
4	S383-1008	1904	385 1/2
5	S383-2007	560	403 2/2
6	S383-2008	560	403 2/2
7	S383-3002	529	380 2/2
8	S383-3008	528	380 2/2
9	S383-5002	527	350 2/2
10	S383-9304	1929	553 1/2

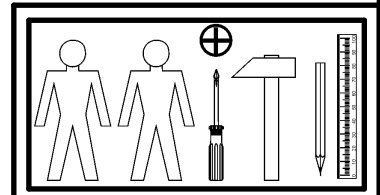

4x a44	4x b19	1x c409 128mm	8x d1 ∅5x17 mm	8x d3 ∅5x17 mm	4x e1 ∅7x50 mm	8x e3 ∅6x13 mm	12x f1 ∅8x30 mm	4x k82\1
60x l1	4x o21 silikon	8x p51 ∅3,5x15 mm	2x p93 ∅4x13 mm	8x r1 ∅15x12 mm #16	8x r42 20\11	1x z28\1	1x z28\2 82x9,5\6,5mm	4x k82\2
1x z28\3 20x20\1,5 mm	4x s2 ∅16	1x z1 4 mm	3x z28\4 ∅3x12mm					
						1x n26\1	1x p38 ∅3,5x16 mm	

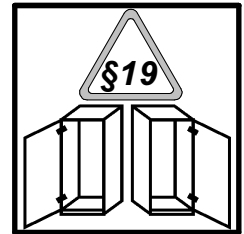
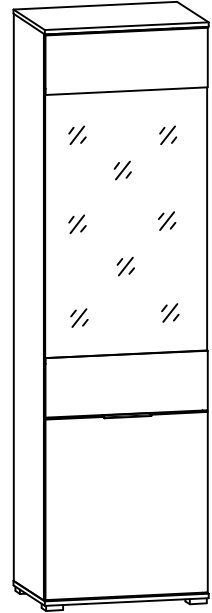
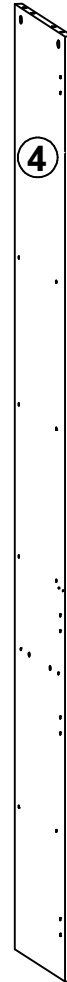
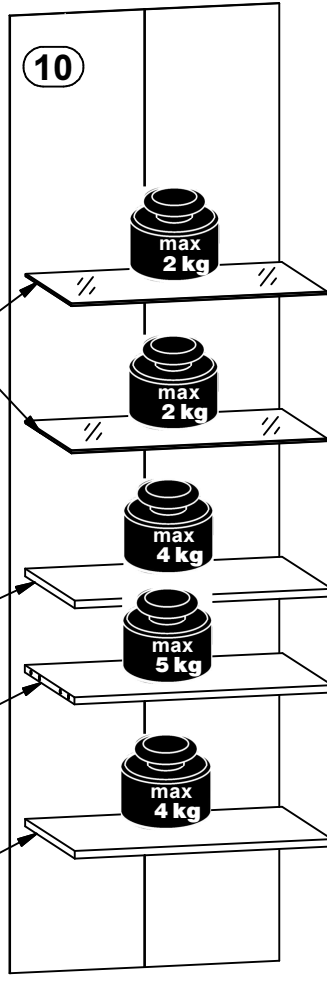
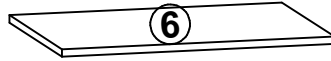
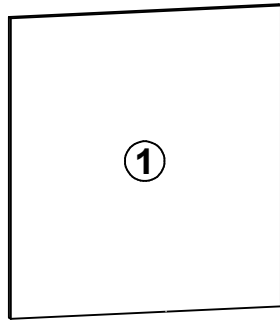
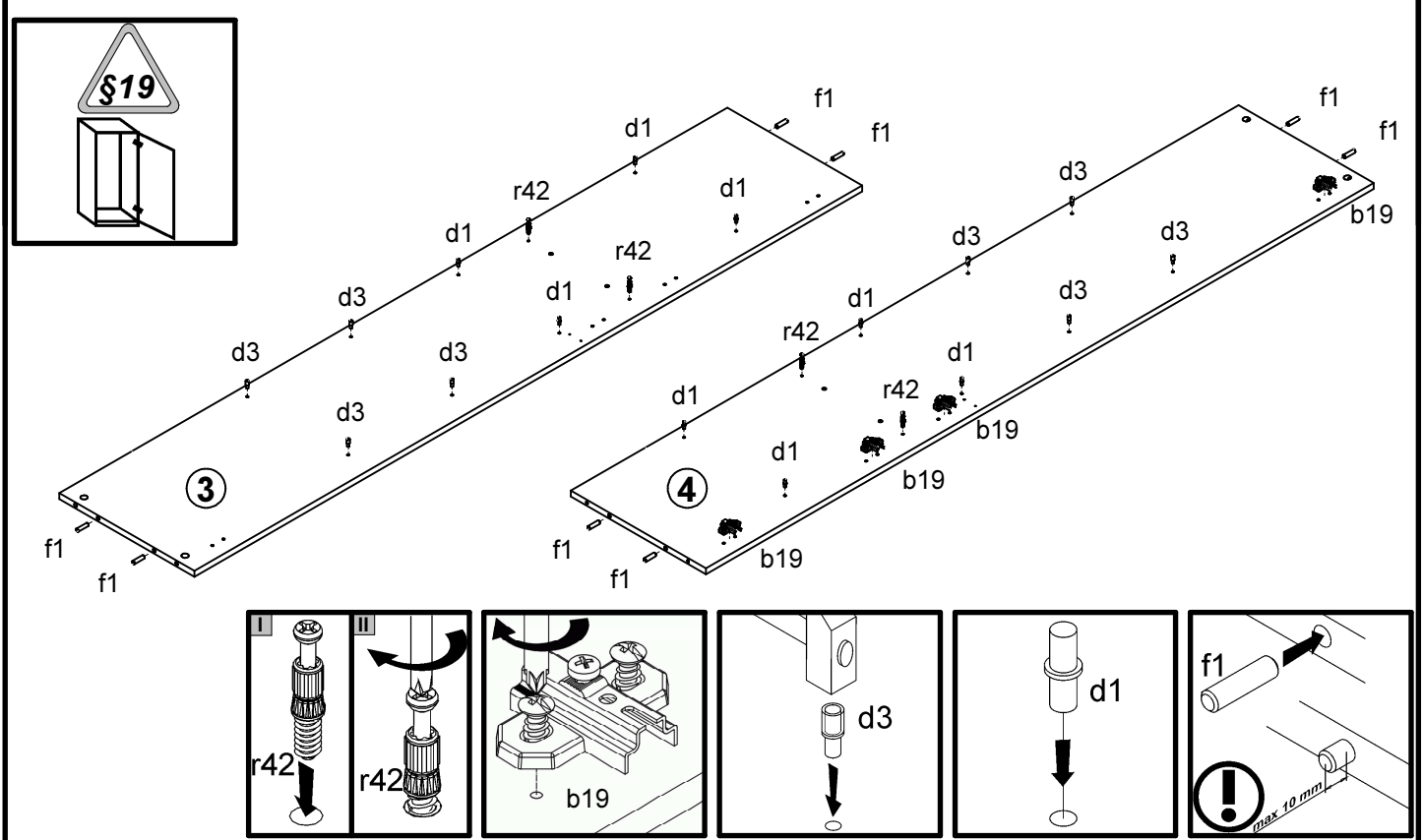
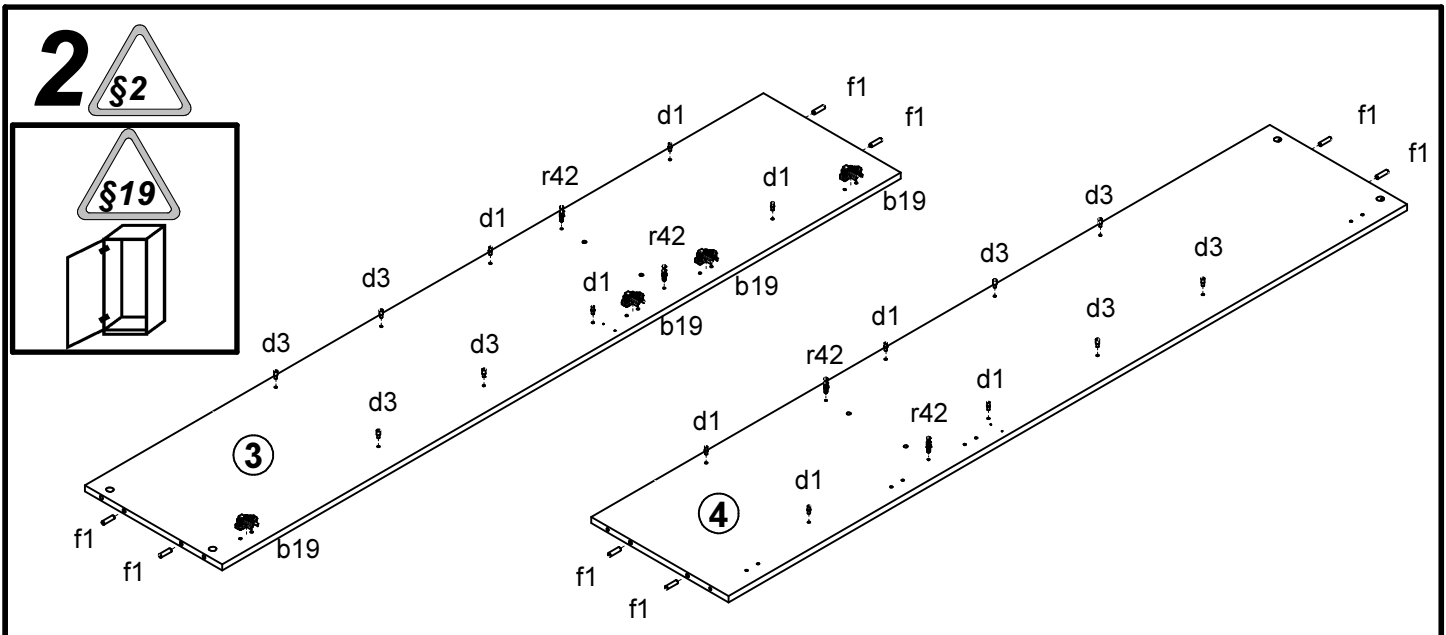
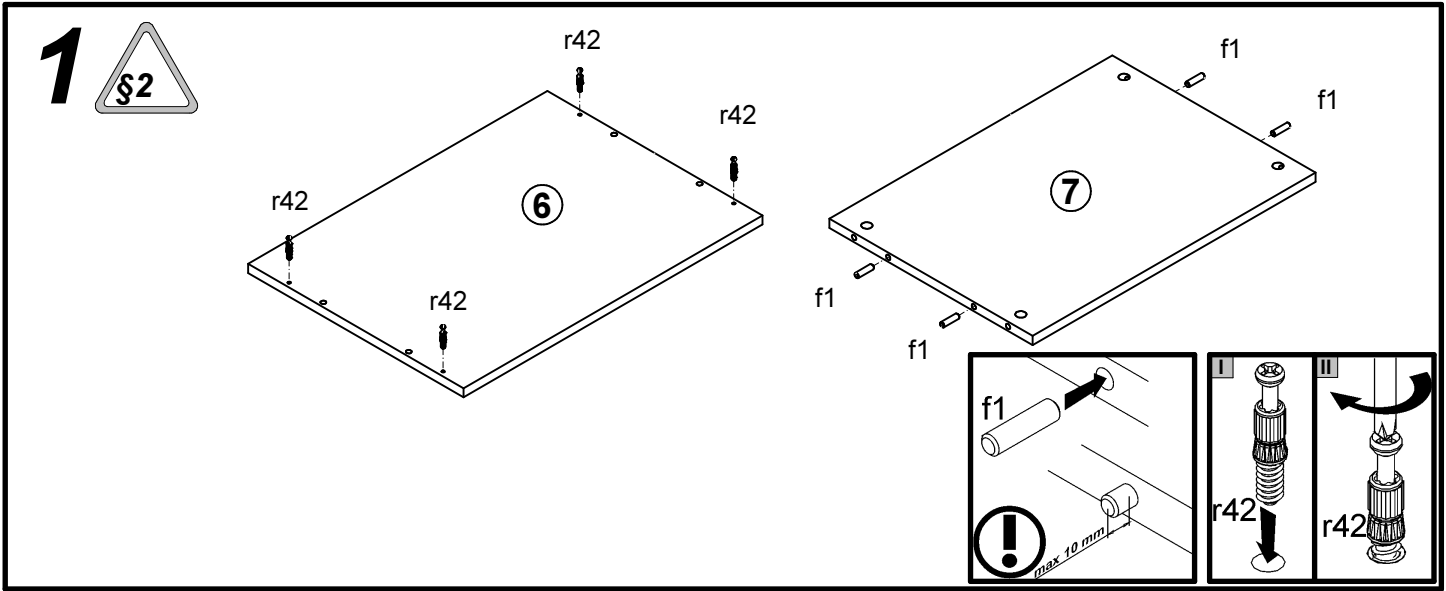

3 §6

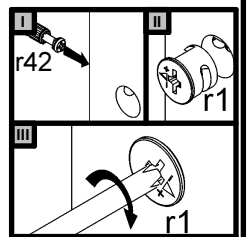
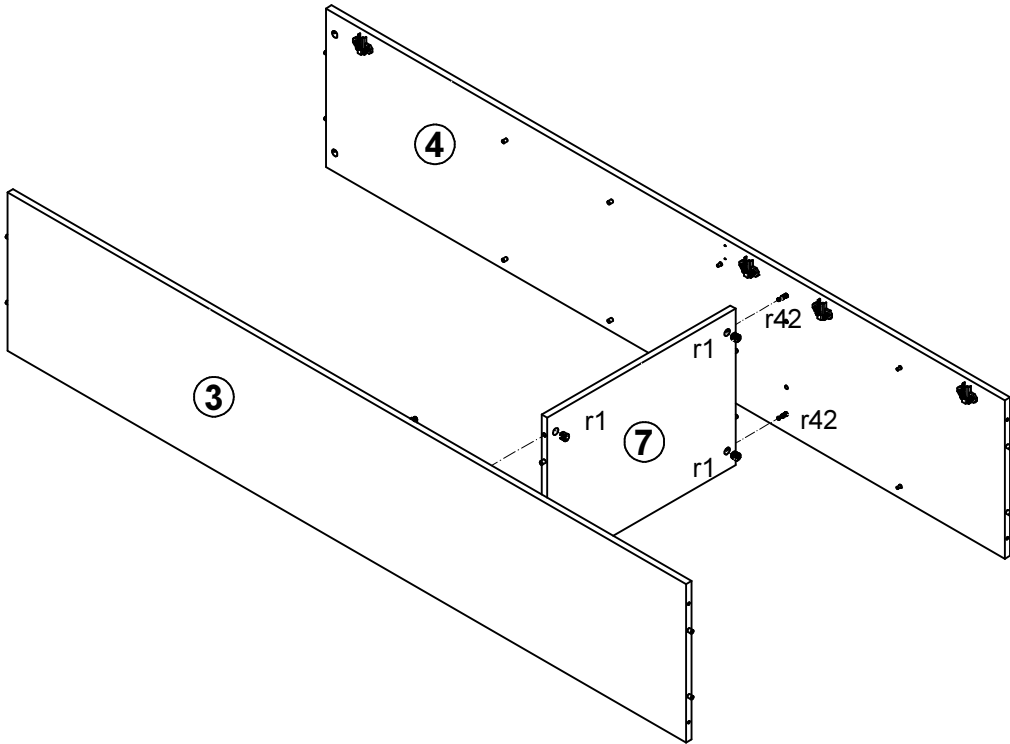
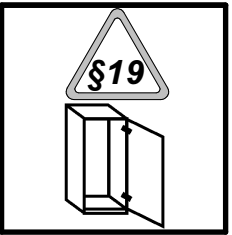
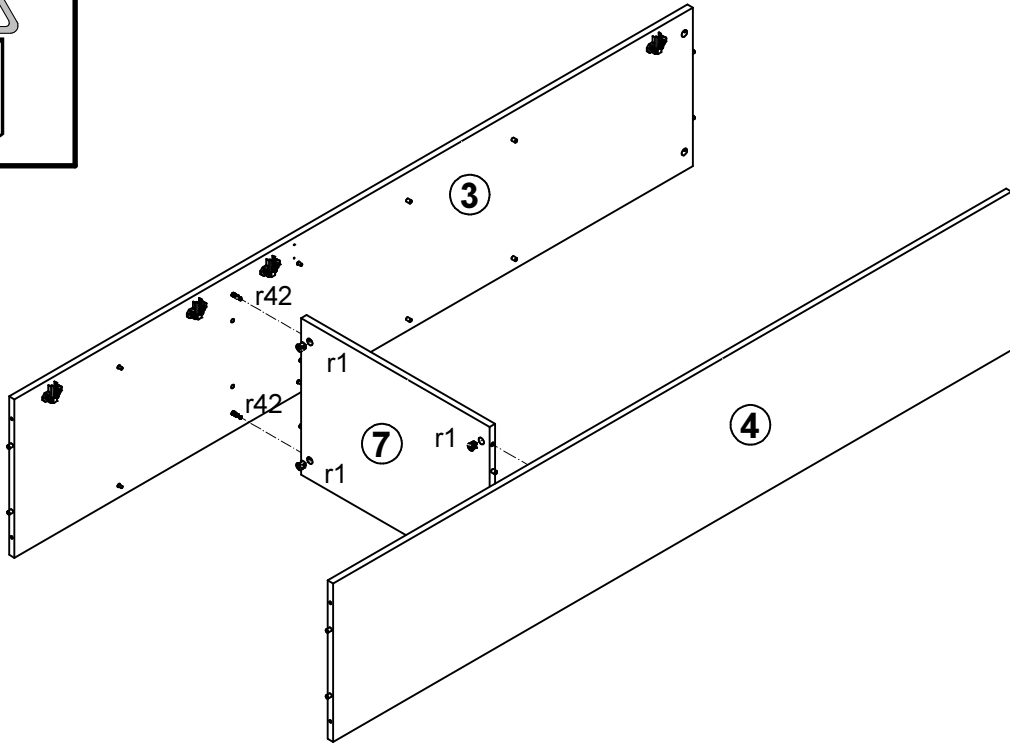
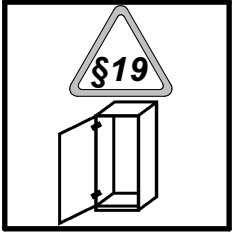

4

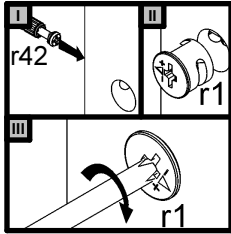
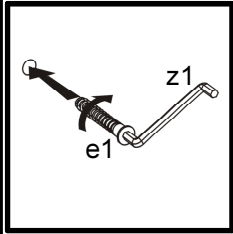
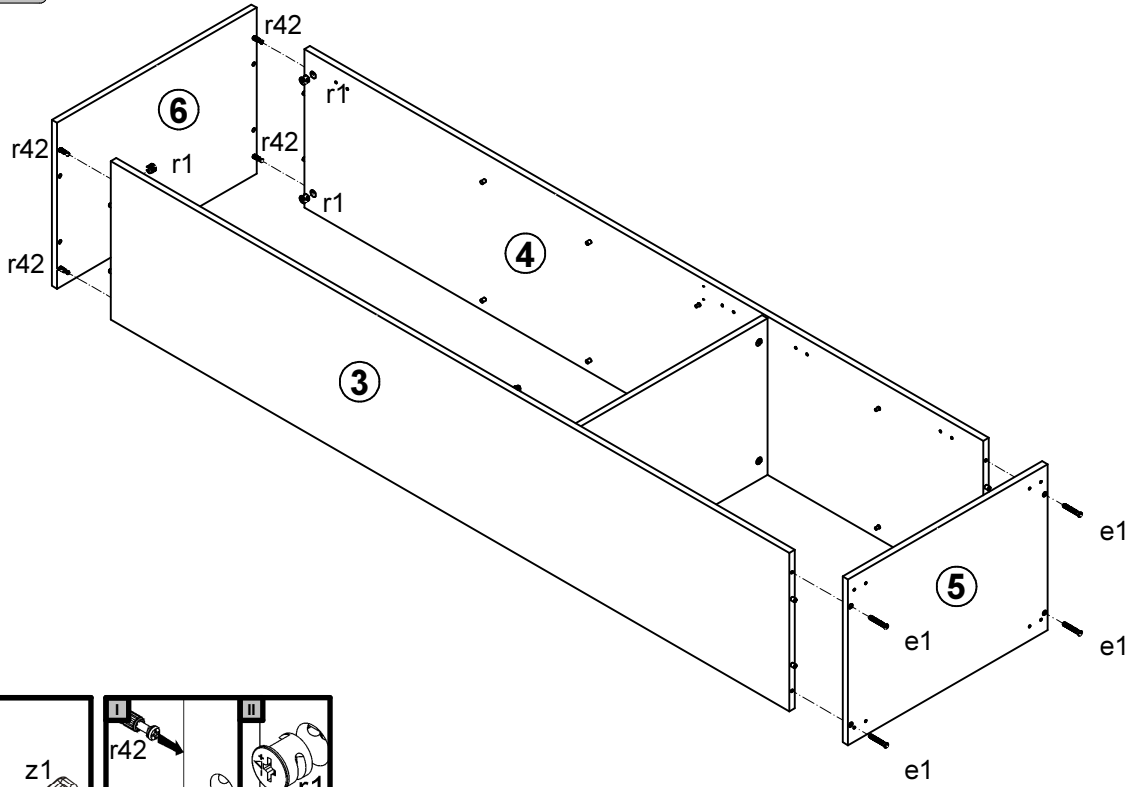

5

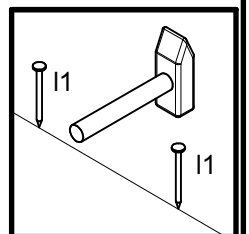
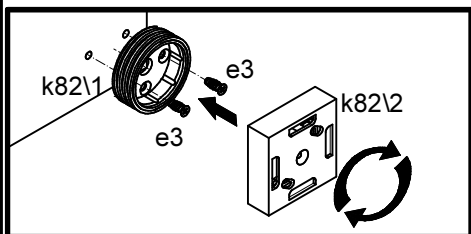
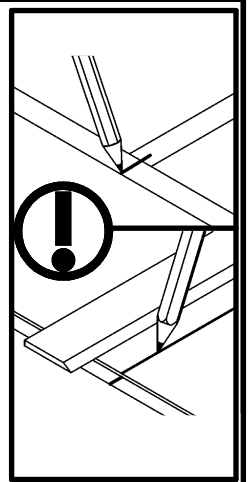
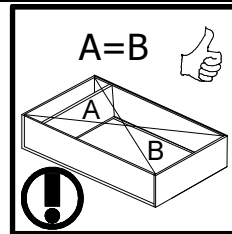
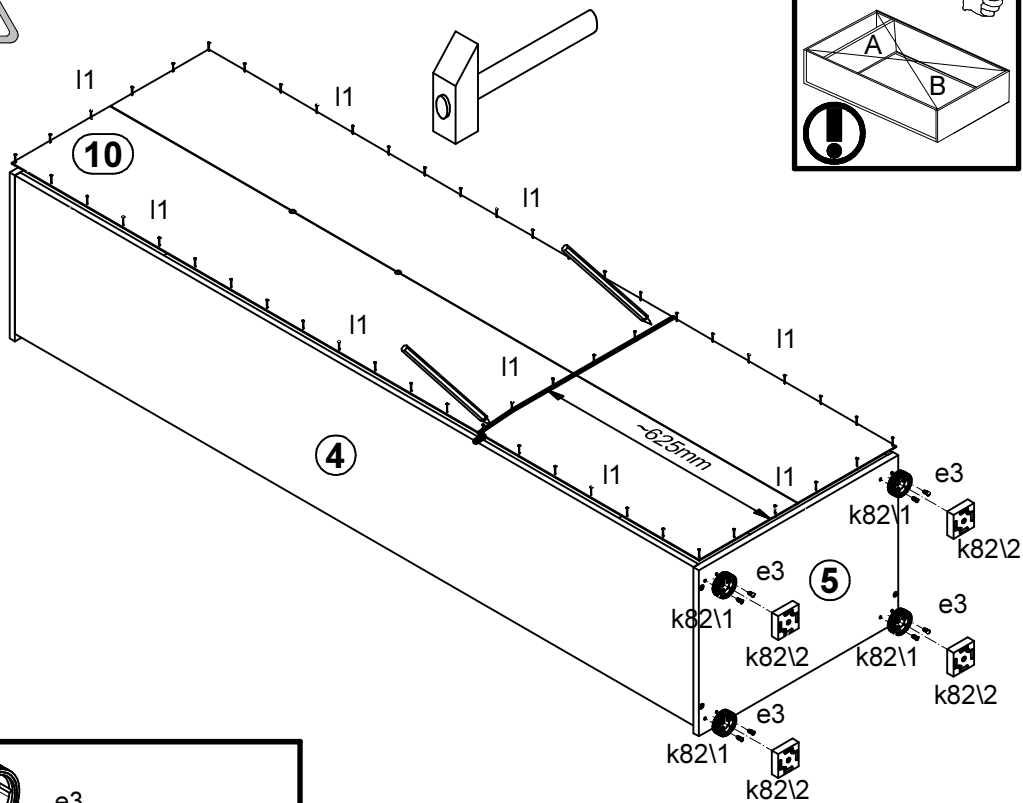

6

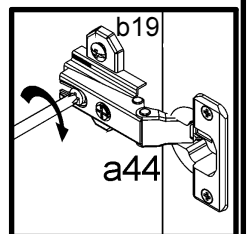
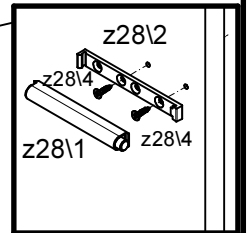
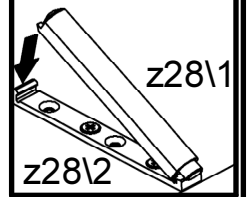
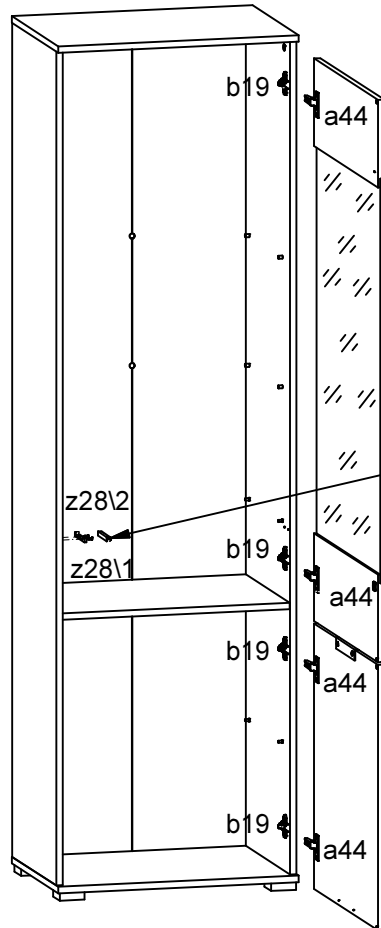
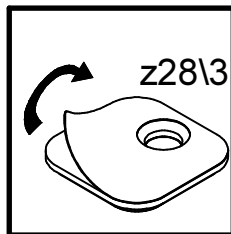
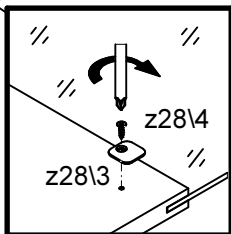
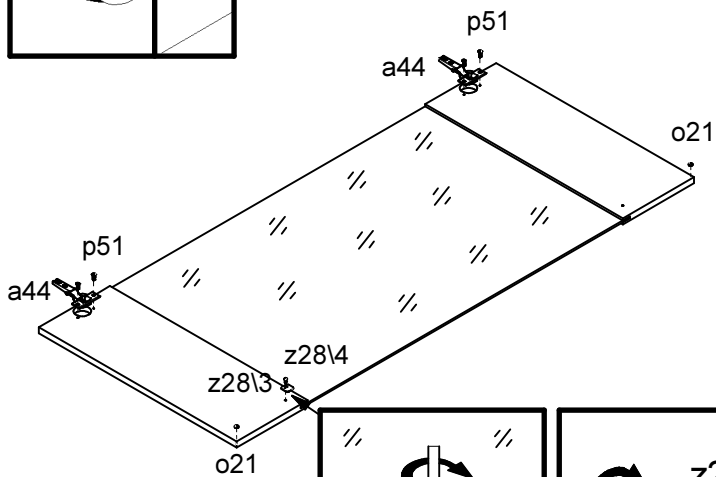
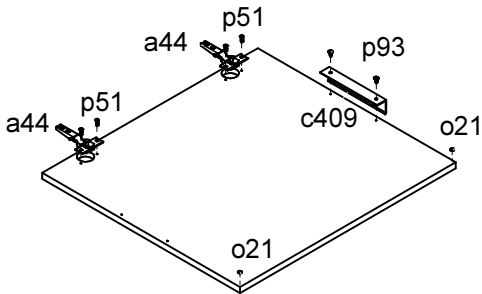
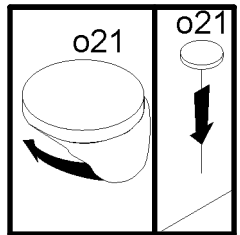
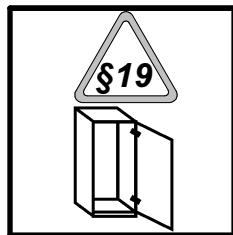
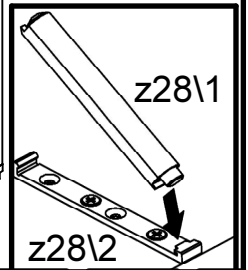
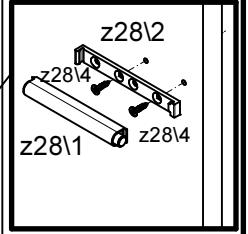
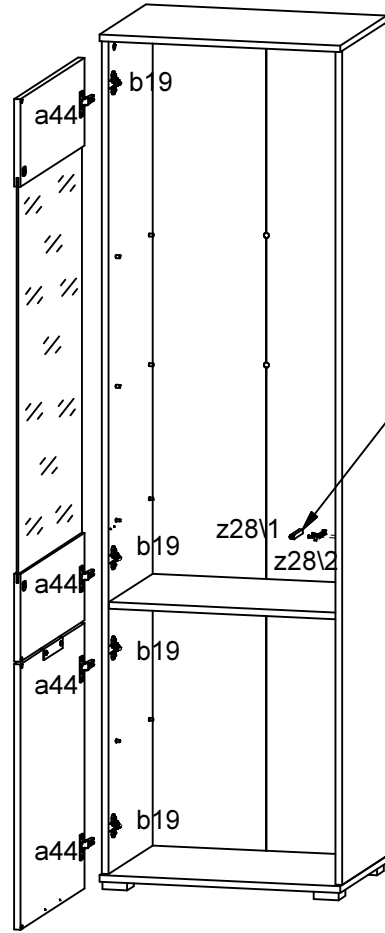
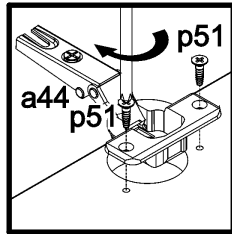
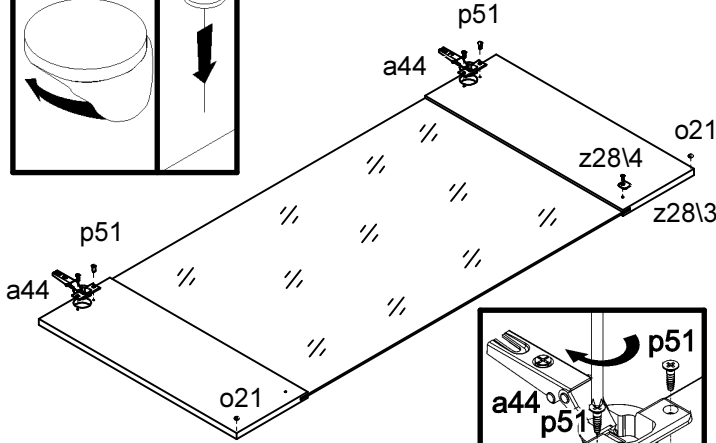
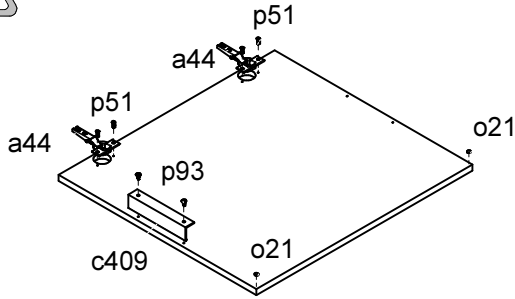
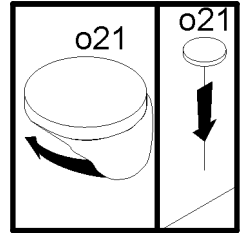
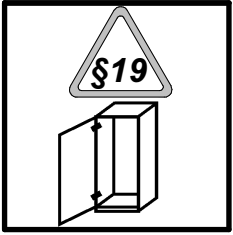

7

