

# NATURO 1

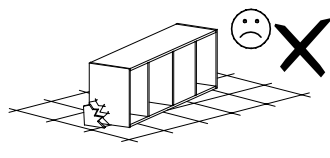

Narzędzia potrzebne do montażu

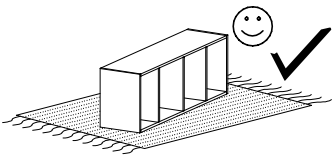
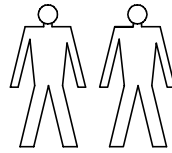
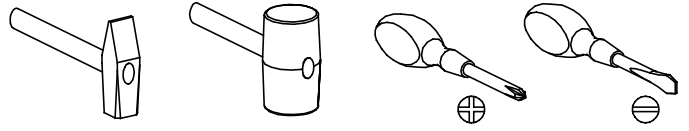

## **UWAGA !!!**

MONTOWANIE USZKODZONYCH  
ELEMENTÓW POWODUJE UTRATĘ  
GWARANCJI

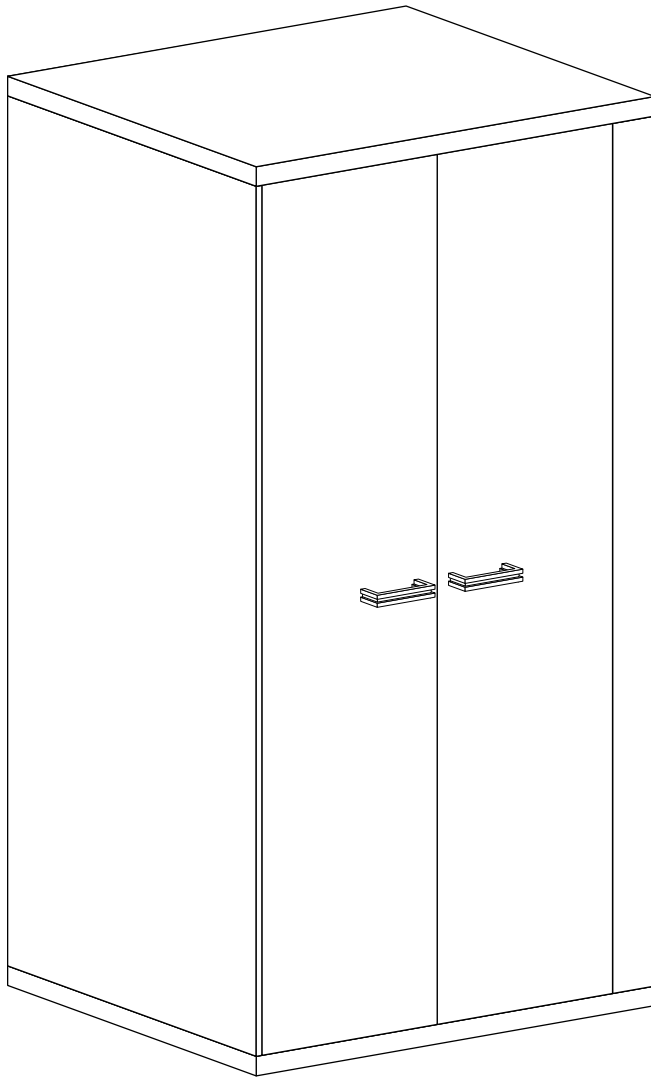

Nr	D[mm]	S[mm]	G[mm]	Ilość
1	1900	576	16	1
2	1900	560	16	1
3	1018	577	48	1
4	1018	577	48	1
5	983	560	16	1
6	983	120	16	1
7	1900	100	16	1
8	1950	1100	2,5	1
9	1894	445	16	2

## **UWAGA !!!**

Mebel zawiera  
elementy drewniane



**R - 1 St.**

W przypadku reklamacji proszę podać numer pakowacza znajdujący się na kartonie.

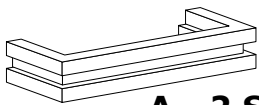

**A - 2 St.**

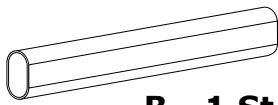

**B - 1 St.**

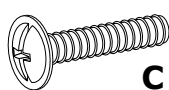

**C - 4 St.**  
4x25 mm

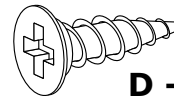

**D - 28 St.**  
3,5x16 mm

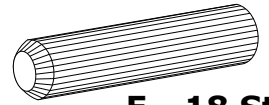

**E - 18 St.**

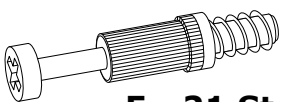

**F - 21 St.**



**G - 21 St.**

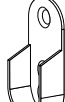

**H - 2 St.**



**I - 80 St.**

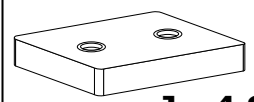

**J - 4 St.**

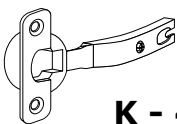

**K - 4 St.**

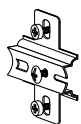

**L - 4 St.**

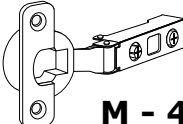

**M - 4 St.**

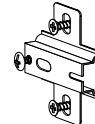

**N - 4 St.**

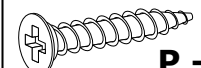

**P - 8 St.**  
3,5x25 mm

I

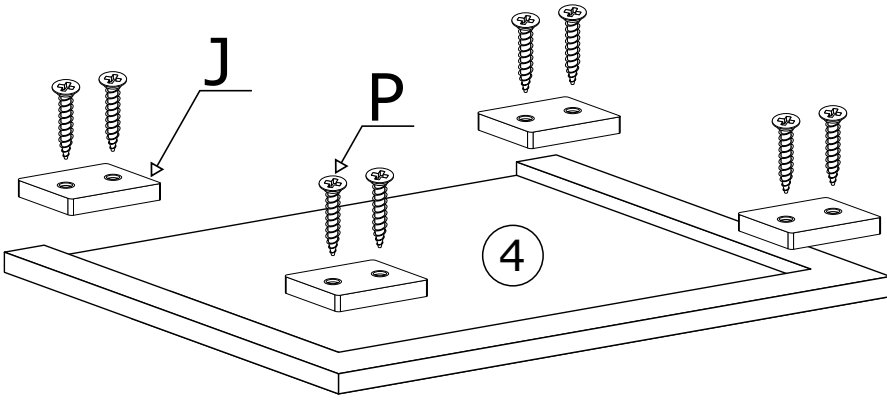

II

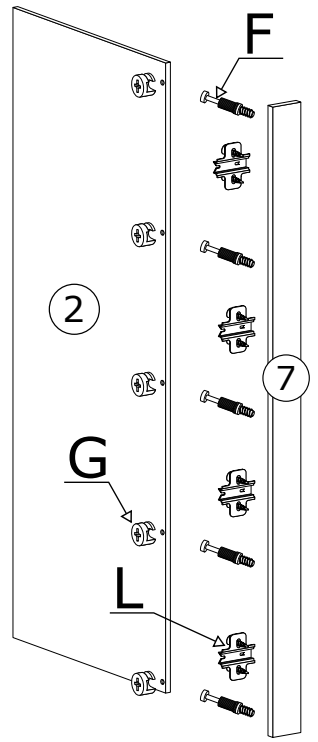

III

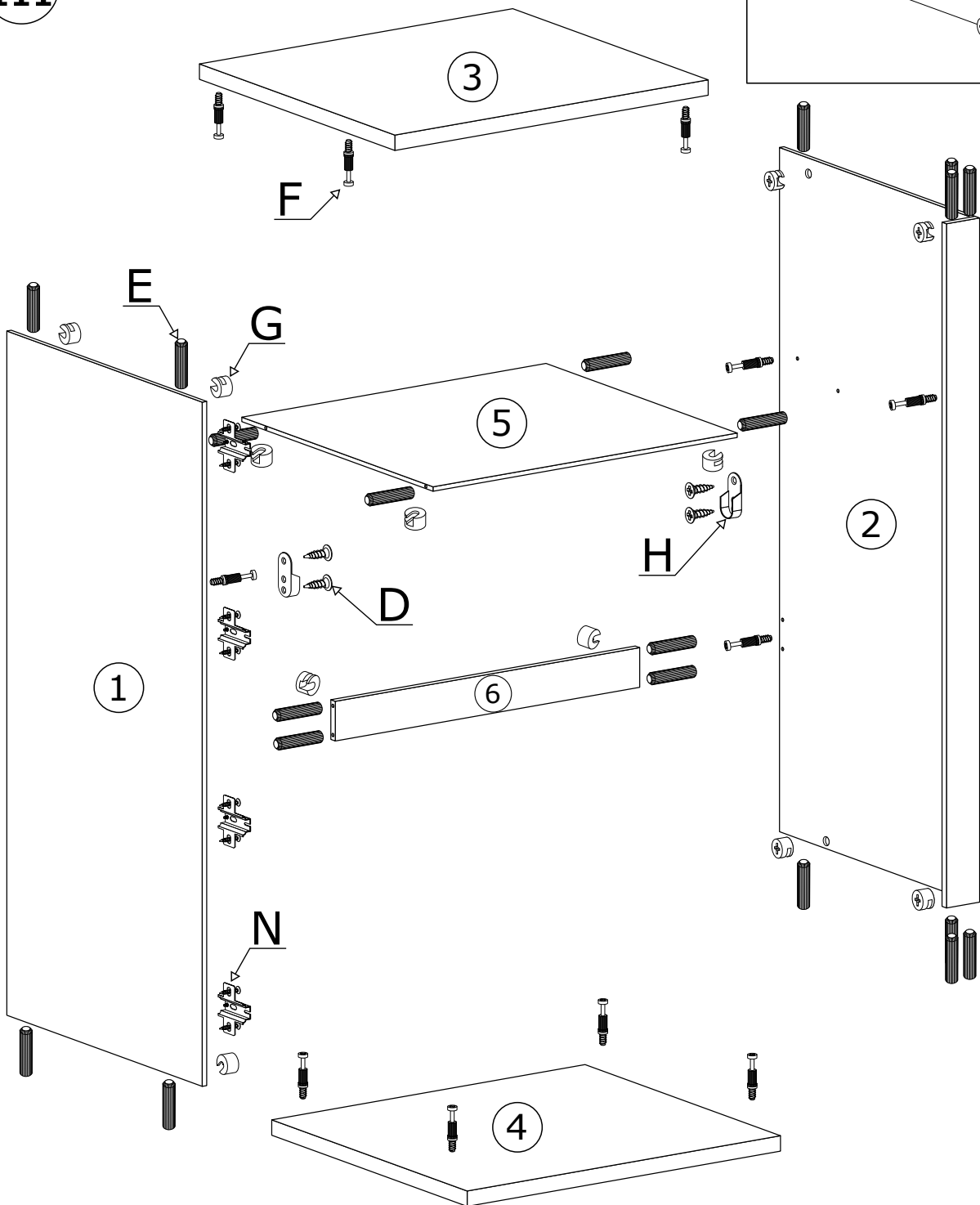

IV

x80

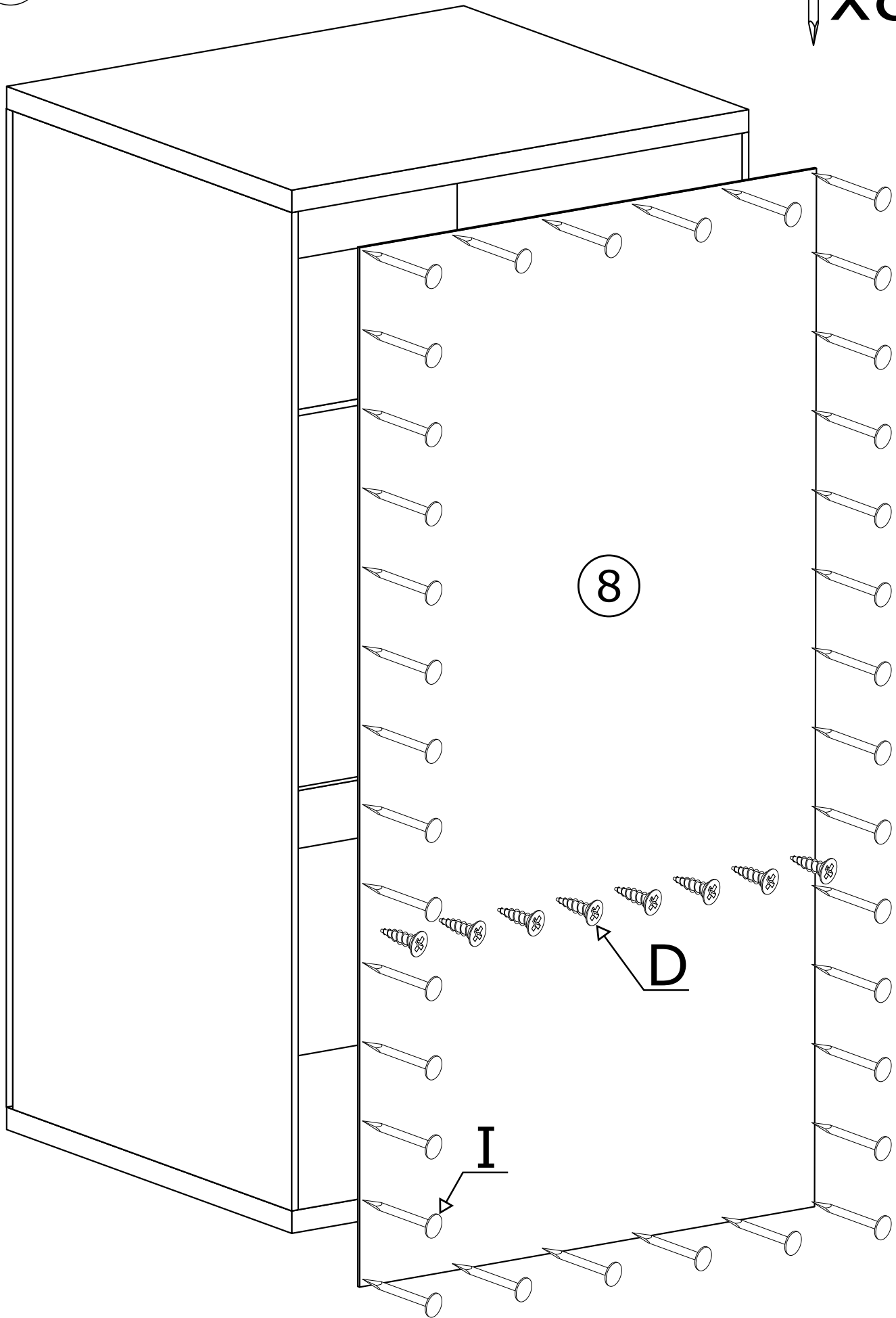

V

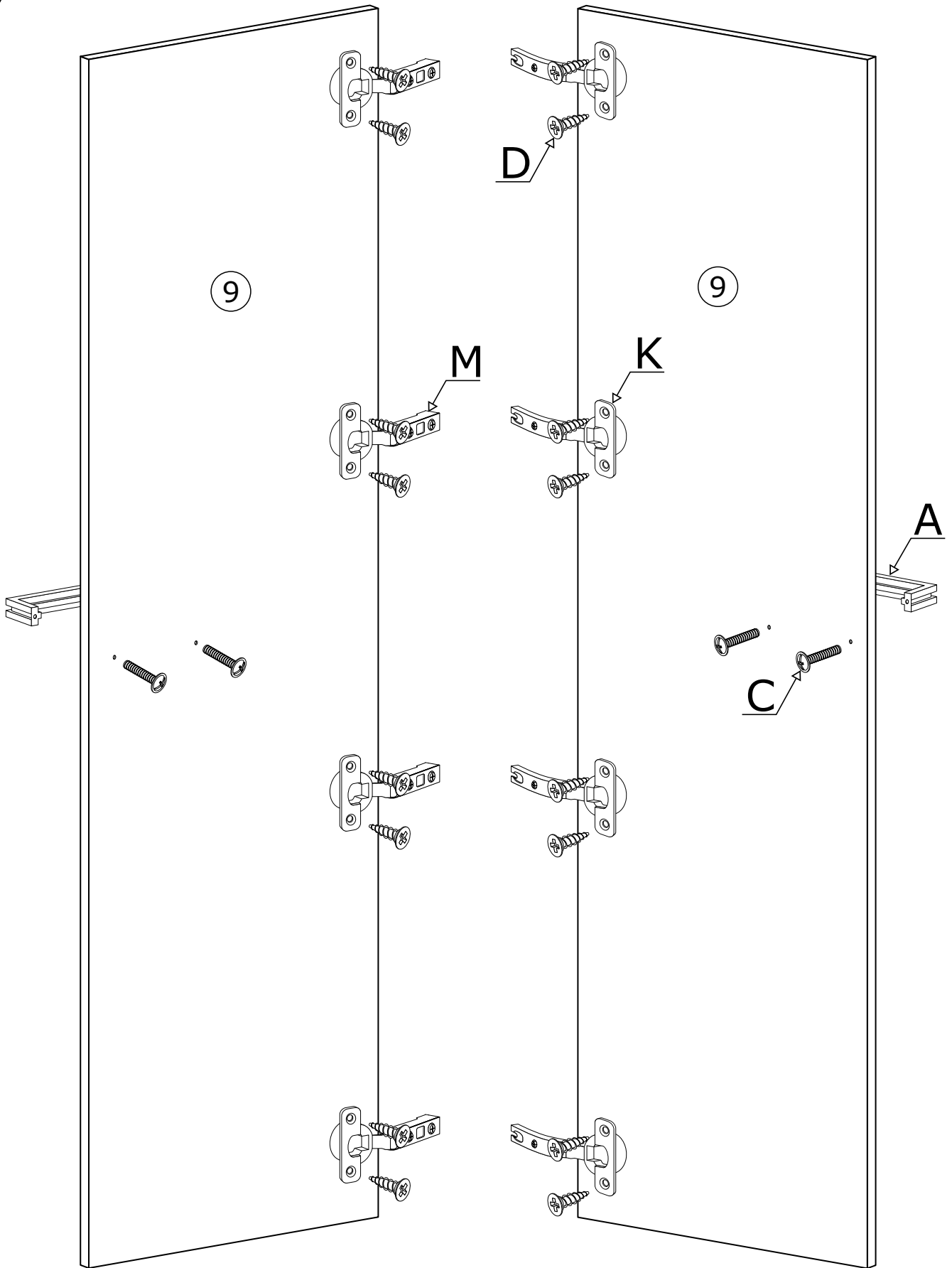

VI

