

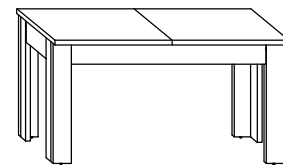

# MXS-35 STÓŁ R

→ 120/160 + 76 × 80



x 36



(a)

x 16

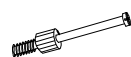

(b)

x 16



(c)

x 4



(d)

x 2



(e)

x 8

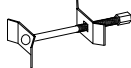

(f)

x 4



(h)

x 2



(i)

x 2



(j)

x 8



(k)

x 12

(6,2x13)



(l)

x 8

(3x13)



(m)

x 24

(3,5x16)



(n)

x 2

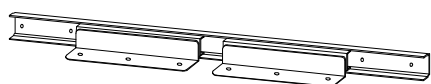

(g)

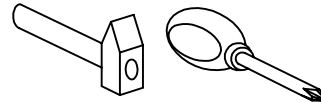

60 min



**1** - FAZY MONTAŻU

**A** - OZNACZENIE ELEMENTÓW

**a** - OZNACZENIE AKCESORIÓW

**1**

x 20



(a)

x 16



(b)

x 6



(c)

x 4



(f)

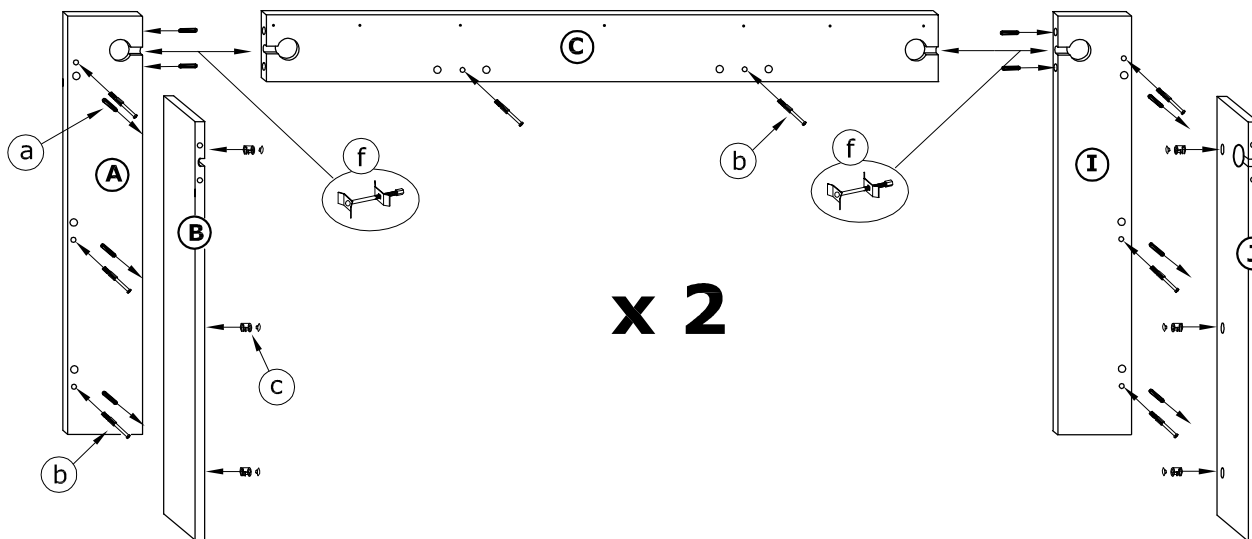

**2**

x 16



(a)

x 4



(c)

x 4



(f)







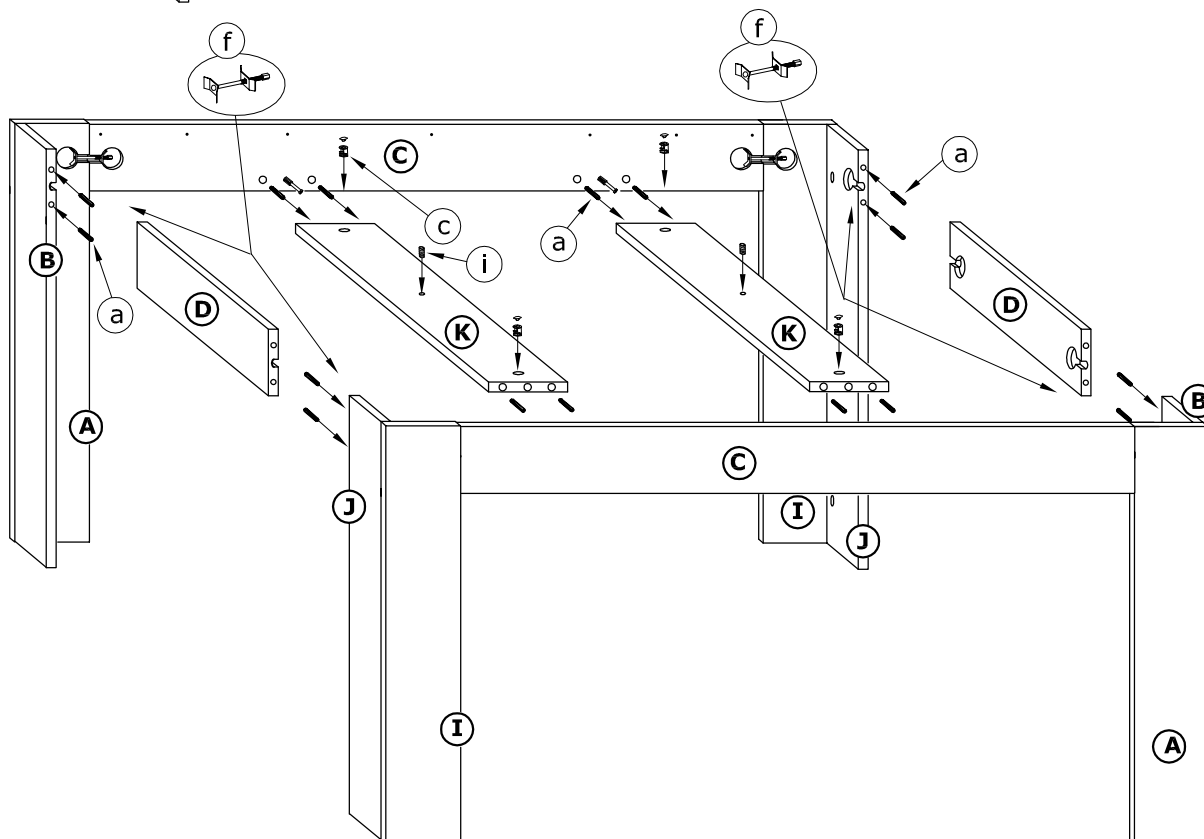

x 2



(i)



3

- x 4 
- x 2 
- x 4 
- x 2 
- x 8 
- x 12 (6,2x13) 
- x 8 (3x13) 
- x 24 (3,5x16) 
- x 2 