

CALI 6

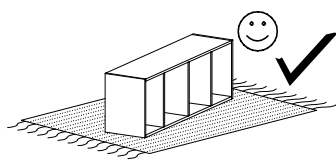

Narzędzia potrzebne do montażu



UWAGA !!!

MONTOWANIE USZKODZONYCH
ELEMENTÓW POWODUJE UTRATĘ
GWARANCJI

Nr	Nazwa elementu	D[mm]	S[mm]	G[mm]	Ilość
1	Bok Lewy	360	386	16	1
2	Bok Prawy	360	370	16	1
3	Błat Górny	1606	406	32	1
4	Błat Dolny	1606	406	32	1
5	Przegroda	360	386	16	2
6	Wieniec	567	386	16	2
7	Półka	389	370	16	1
8	Kapak	1582	400	2,5	1
9	Bok Szuflady	350	150	16	4
10	Tył Szuflady	532	150	16	2
11	Przód Szuflady	590	190	16	2
12	Kapak Szuflady	538	355	2,5	2
13	Drzwi z Lamelami	354	402	32	1

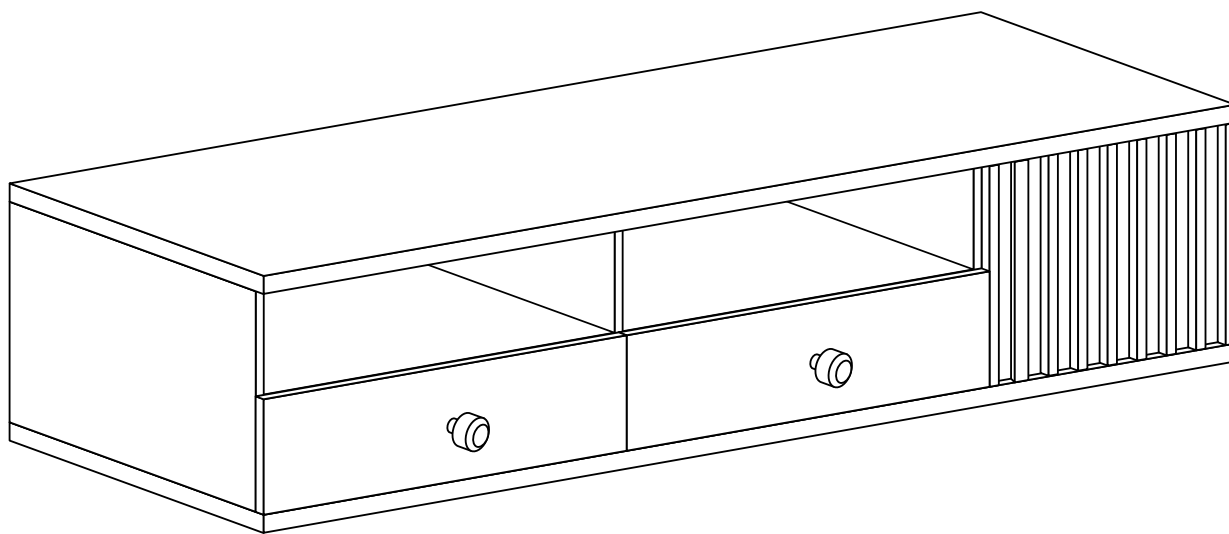

W przypadku reklamacji proszę podać numer pakowacza znajdujący się na kartonie.

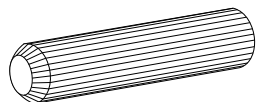

A - 28 St.

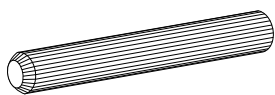

A1 - 2 St.

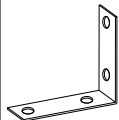

Y1 - 1 St.

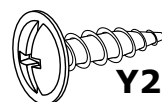

Y2 - 2 St.
3,5x16 mm



X1 - 24 St.

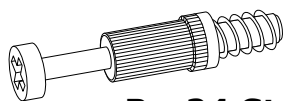

B - 24 St.

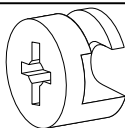

C - 24 St.

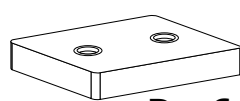

D - 6 St.



E - 12 St.
3,5x25 mm

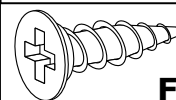

F - 4 St.
3,5x16 mm

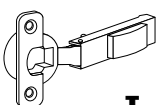

I - 2 St.

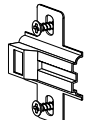

J - 2 St.

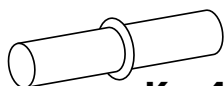

K - 4 St.

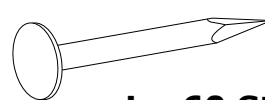

L - 60 St.

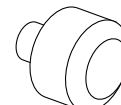

N - 2 St.

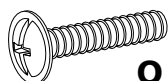

O - 2 St.
3,5x22 mm

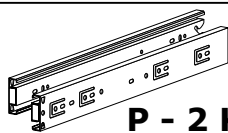

P - 2 Kpl.

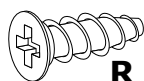

R - 16 St.
5x13 mm



S - 8 St.

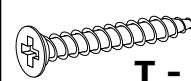

T - 28 St.
3x30 mm

I

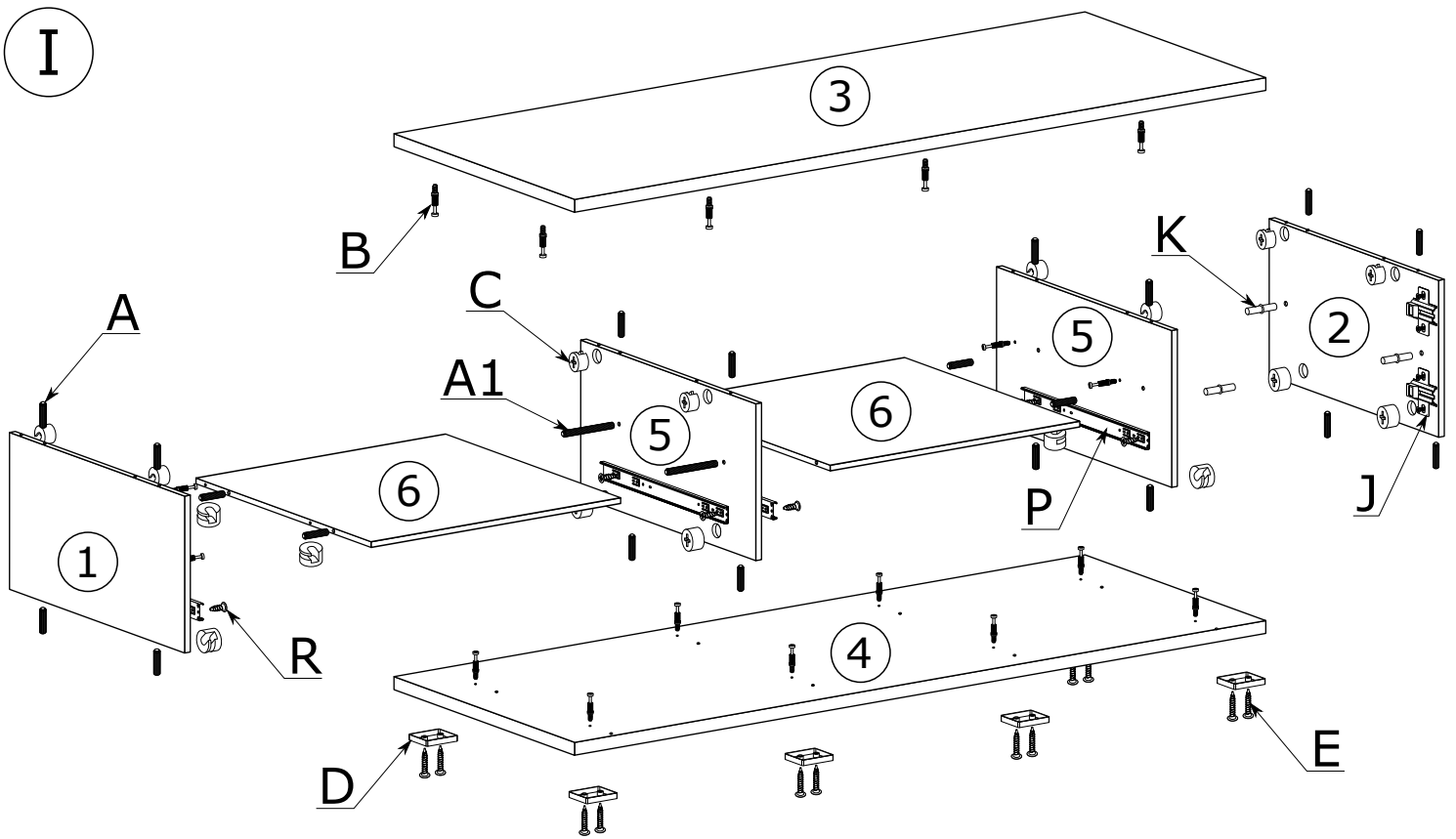

II

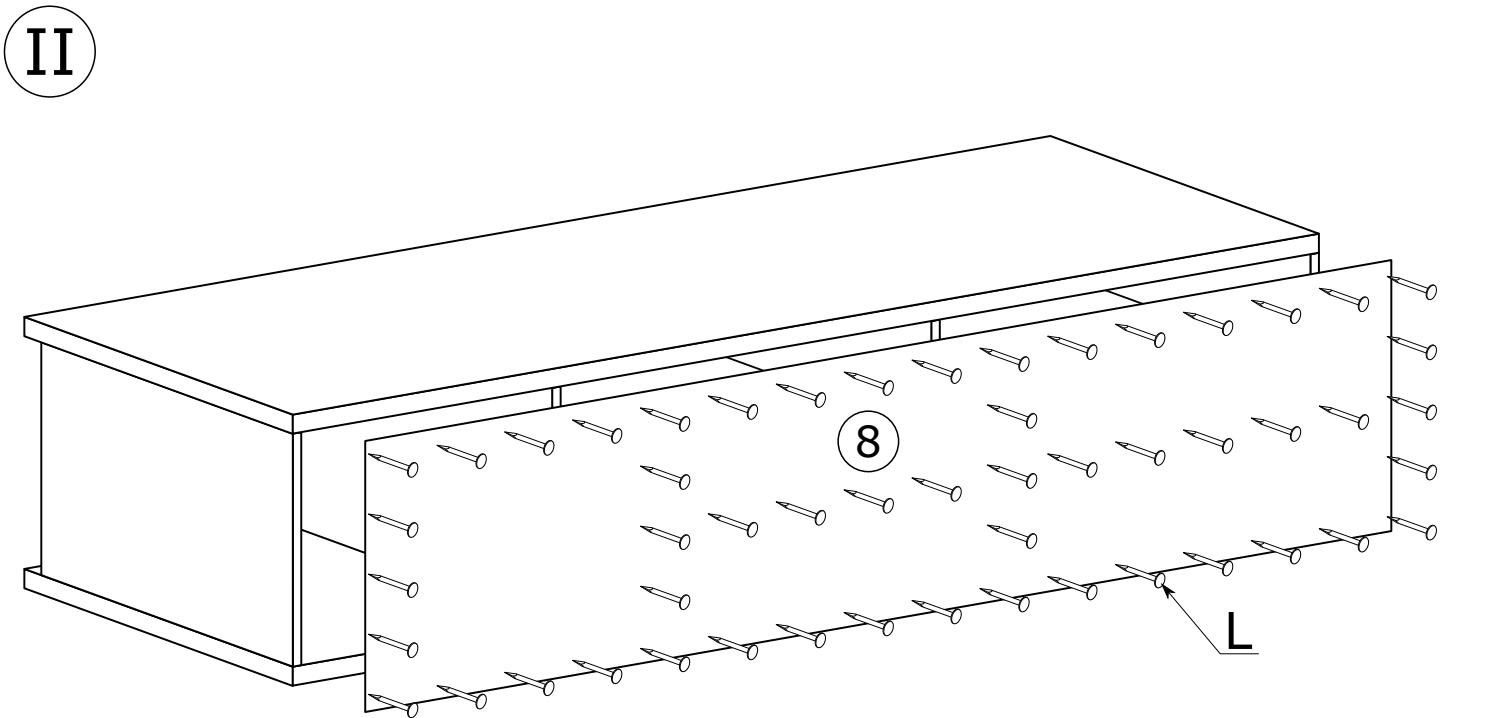

x60

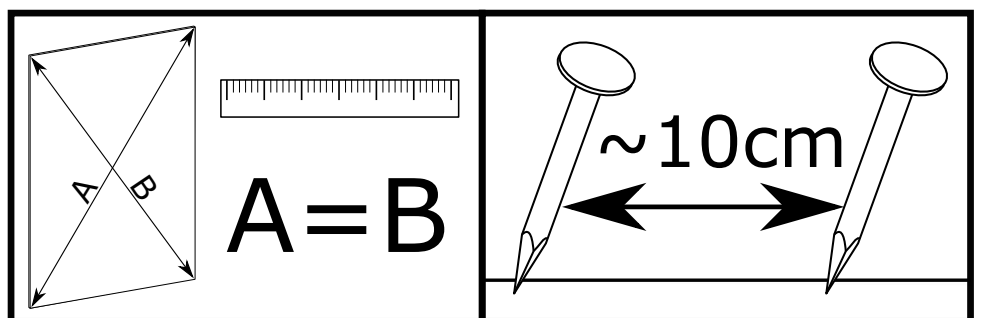

III

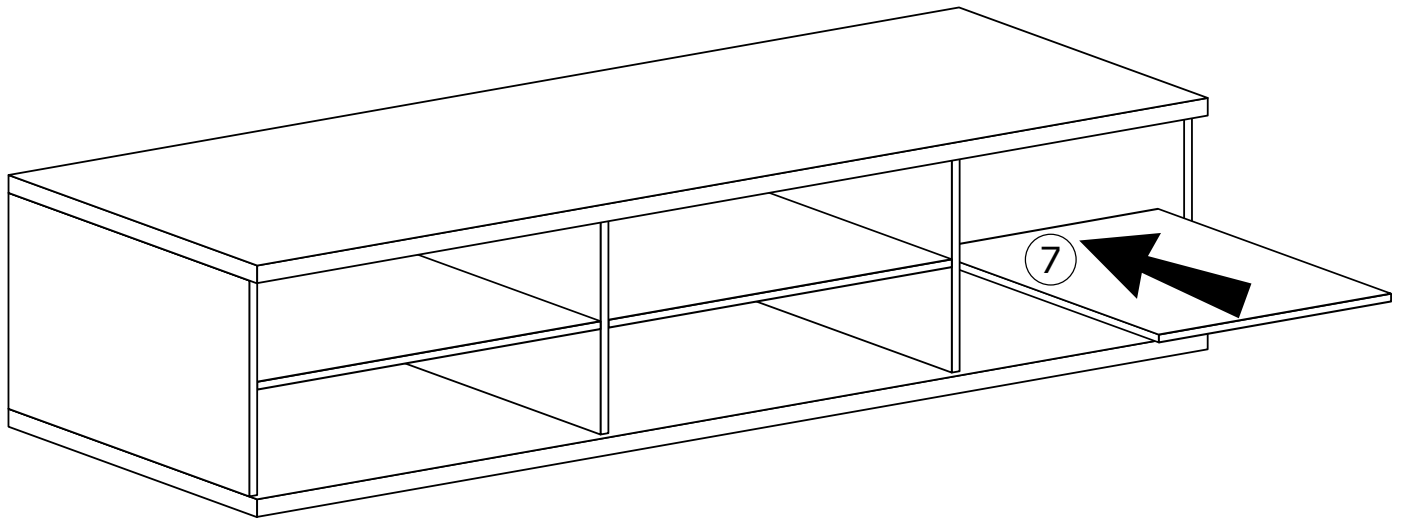

IV

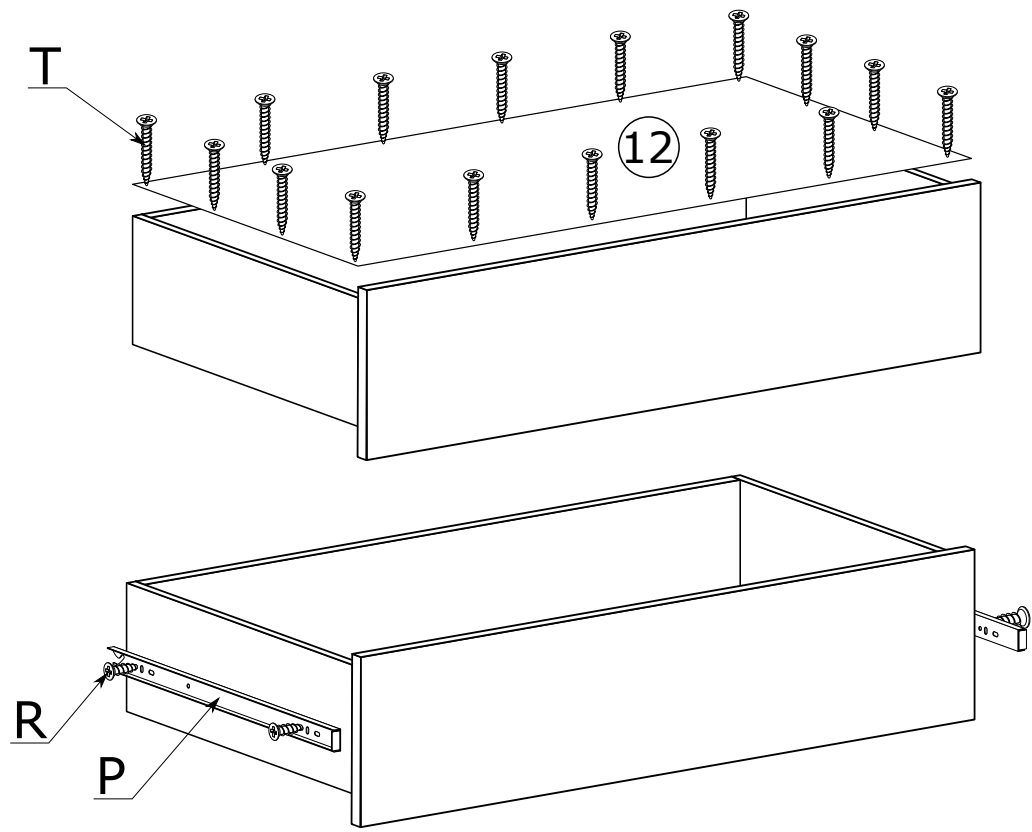
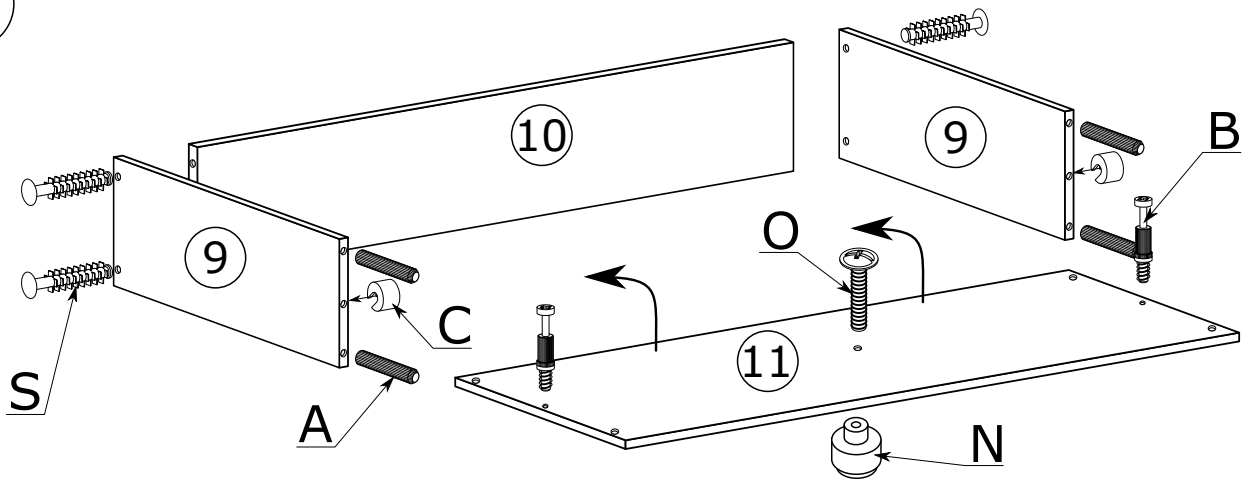

V

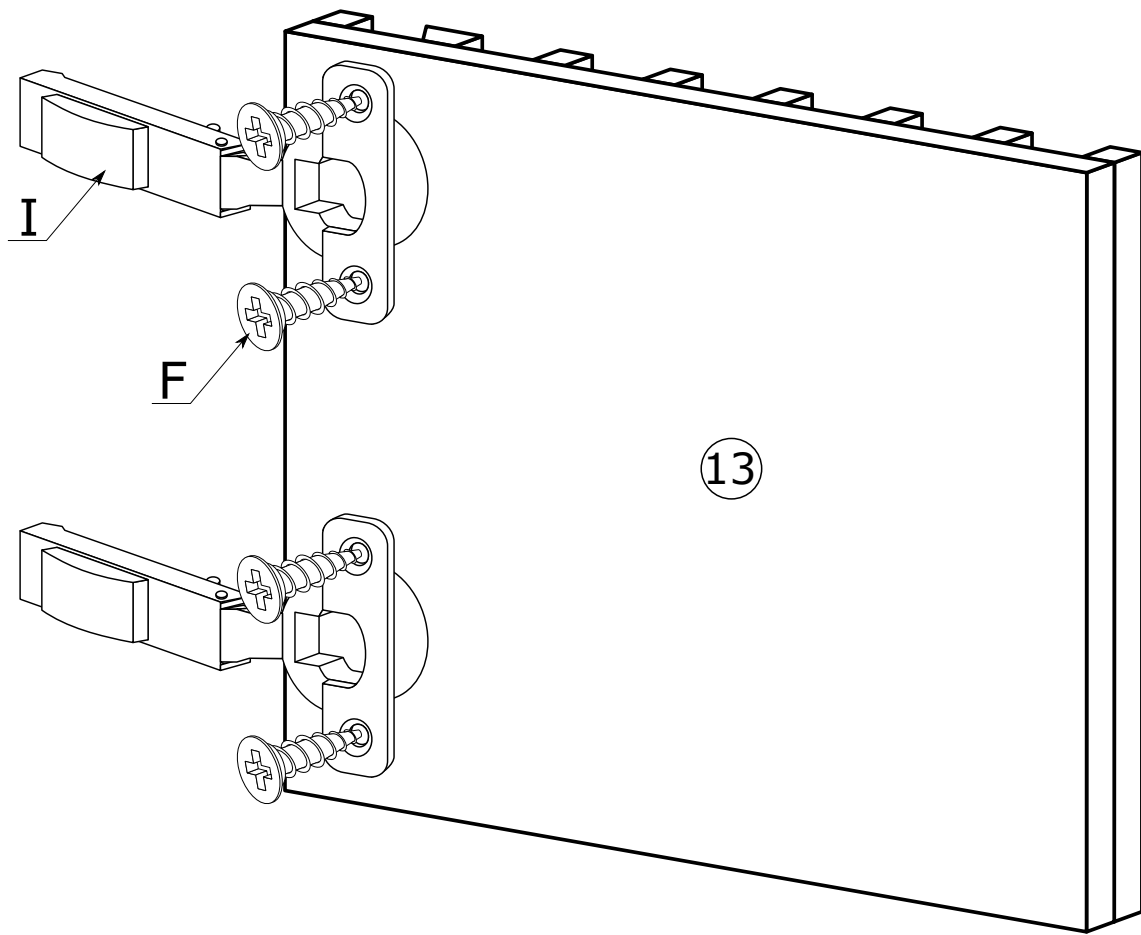

VI

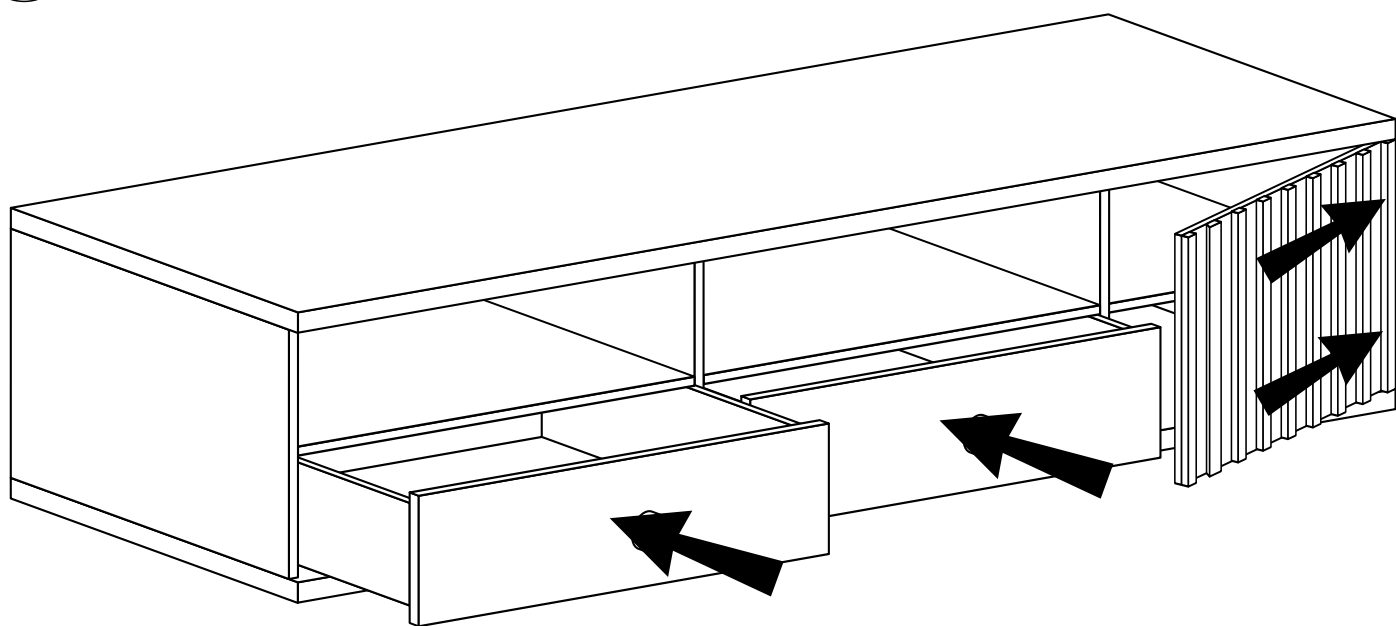

MONTAŻ/DEMONTAŻ PROWADNIC

1



2

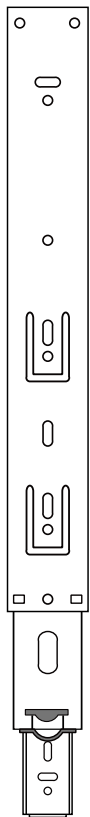

3

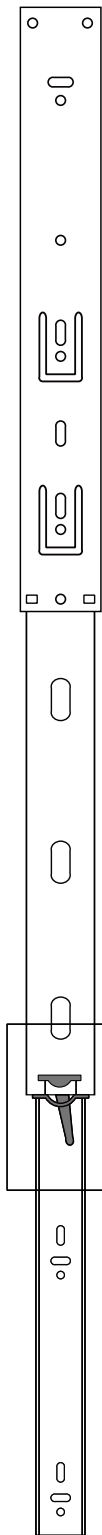

4

