

АРГУС

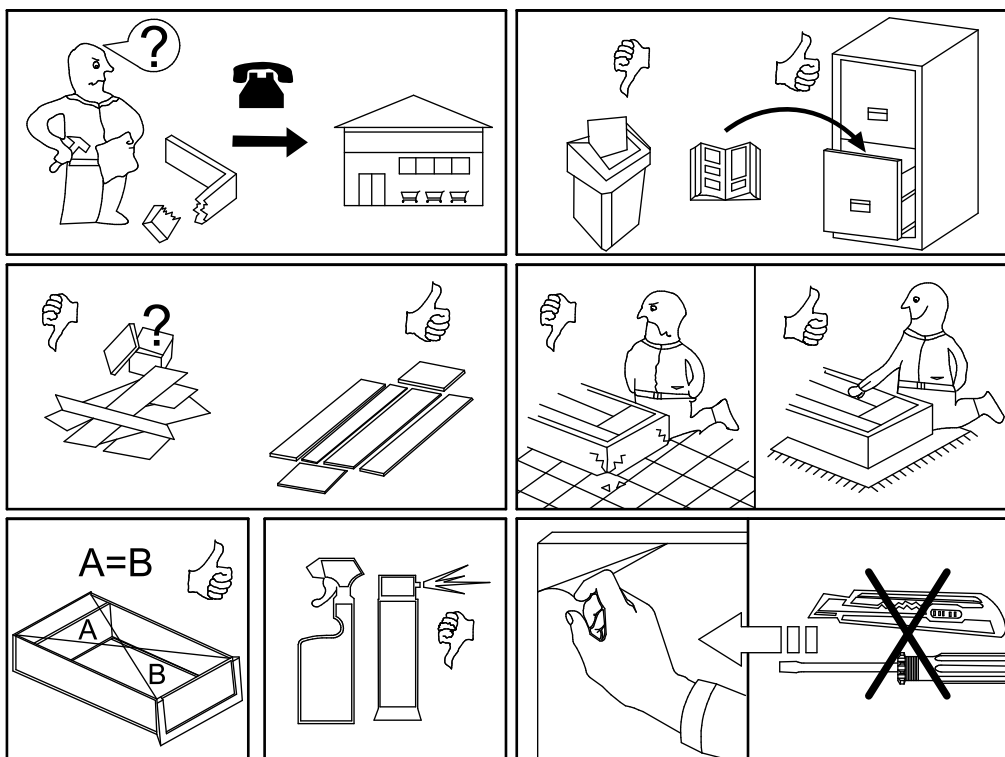

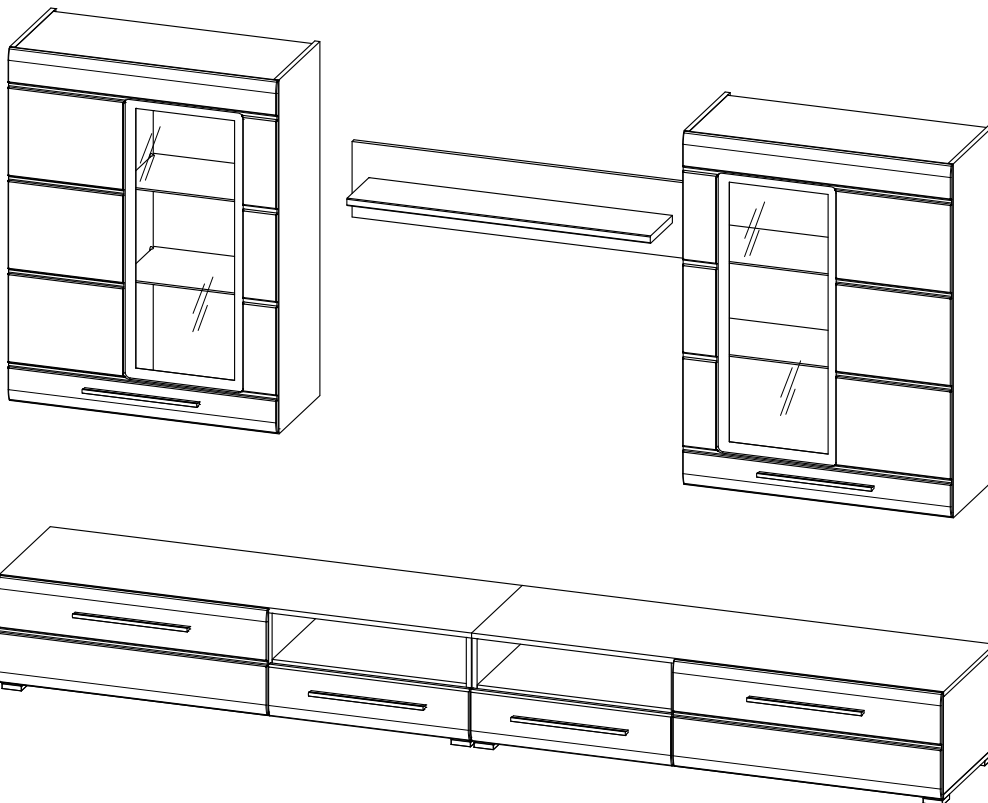

4x K16 a1	6x K0 a2	10x b1	6x L 340 mm c520	16x d3	16x e1
8x e3 φ6x13 mm	4x e4 φ5x11 mm	8x e32 φ5x50 mm	60x f29 φ8x35 mm	2x g2	4x j2 M4x9 mm
10x 56x56/20 mm k52	132x l1	20x l2	16x 3 mm l3	2x m48	2x n2
2x 50x12/1,5 mm n3	4x n10	12x 20x13x3,5/1mm n108	4x n122/1	4x silikon φ8x1,8mm o21	4x o43/1
1x o43/6	8x p1 φ3,5x13 mm	4x p5 φ3,5x13 mm	18x p9 φ4x30 mm	28x p21 φ4x30 mm	
12x φ2,9x16 mm p55	16x φ3x16 mm p52	4x φ3x10 mm p100	60x φ15x12mm #16 r1	4x φ12x10,5mm #12 r15	64x 30/11 r23
52x ø16 s2	4x ø5 s4	4x 310 mm w4	1x GLUE y1	1x z1	

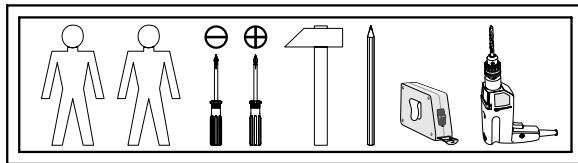
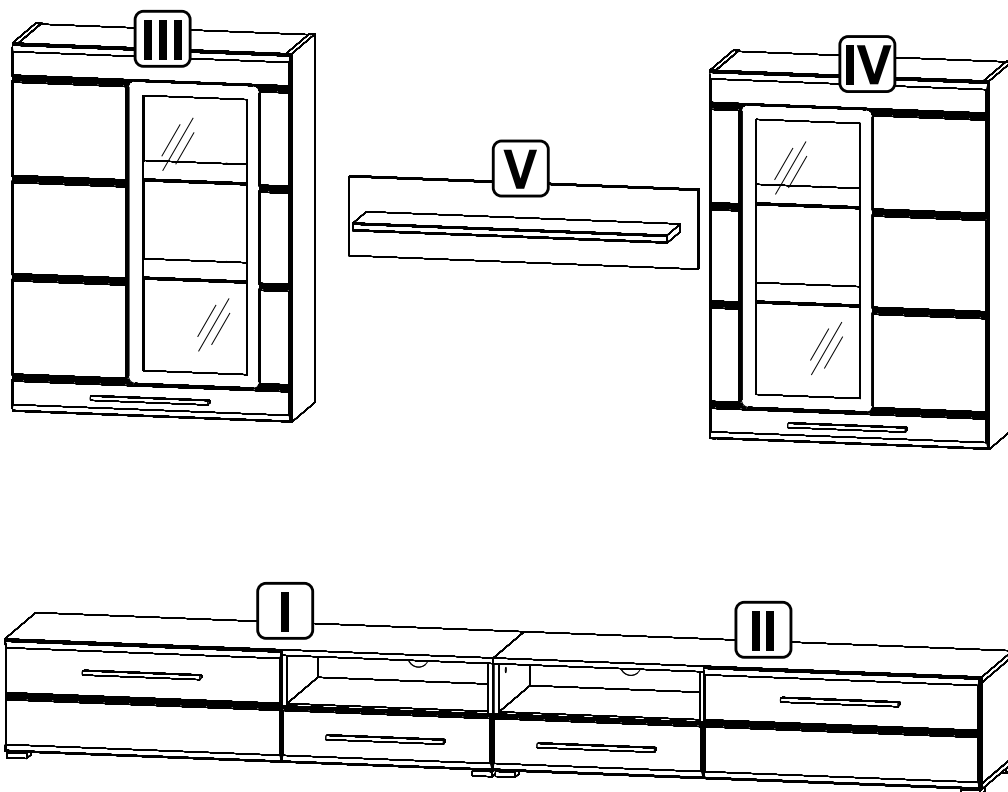
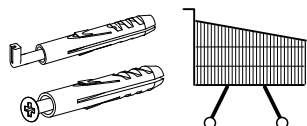

I Тумба РТВ ліва / Тумба РТВ левая

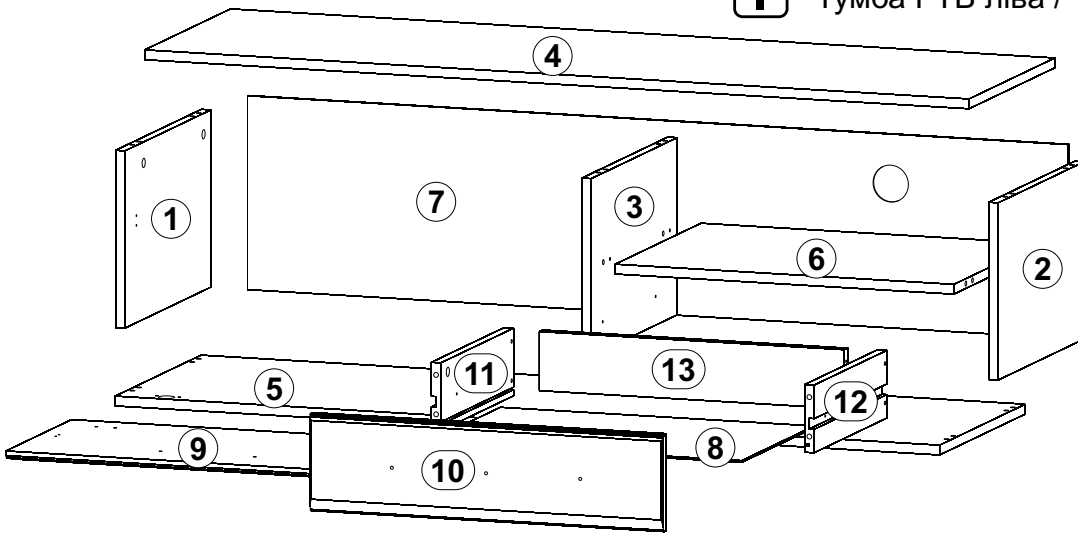

A	B	C	D	
1	PU1-101	288	413	1/5
2	PU1-103	288	413	1/5
3	PU1-102	288	413	1/5
4	PU1-201	1400	413	1/5
5	PU1-220	1400	413	1/5
6	PU1-301	575	413	1/5
7	PU1-901	1394	315	1/5

A	B	C	D	
8	PU1-904	554	378	1/5
9	PU1-017A	792	316	5/5
10	PU1-003A	600	158	5/5
11	PU1-551	375	100	5/5
12	PU1-552	375	100	5/5
13	PU1-553	543	85	3/5



1

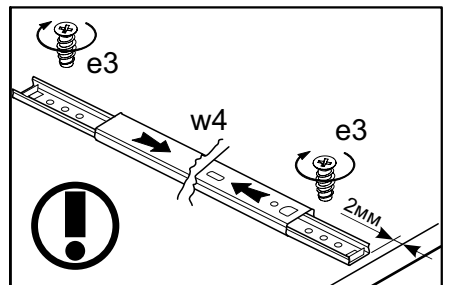
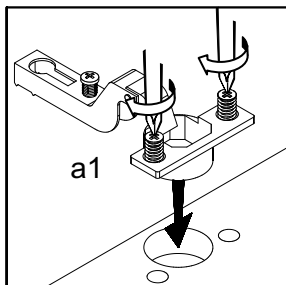
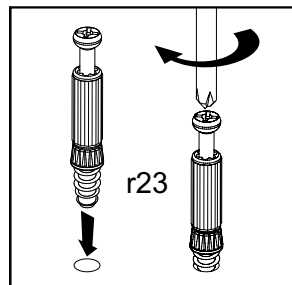
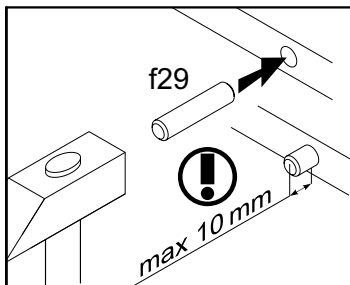
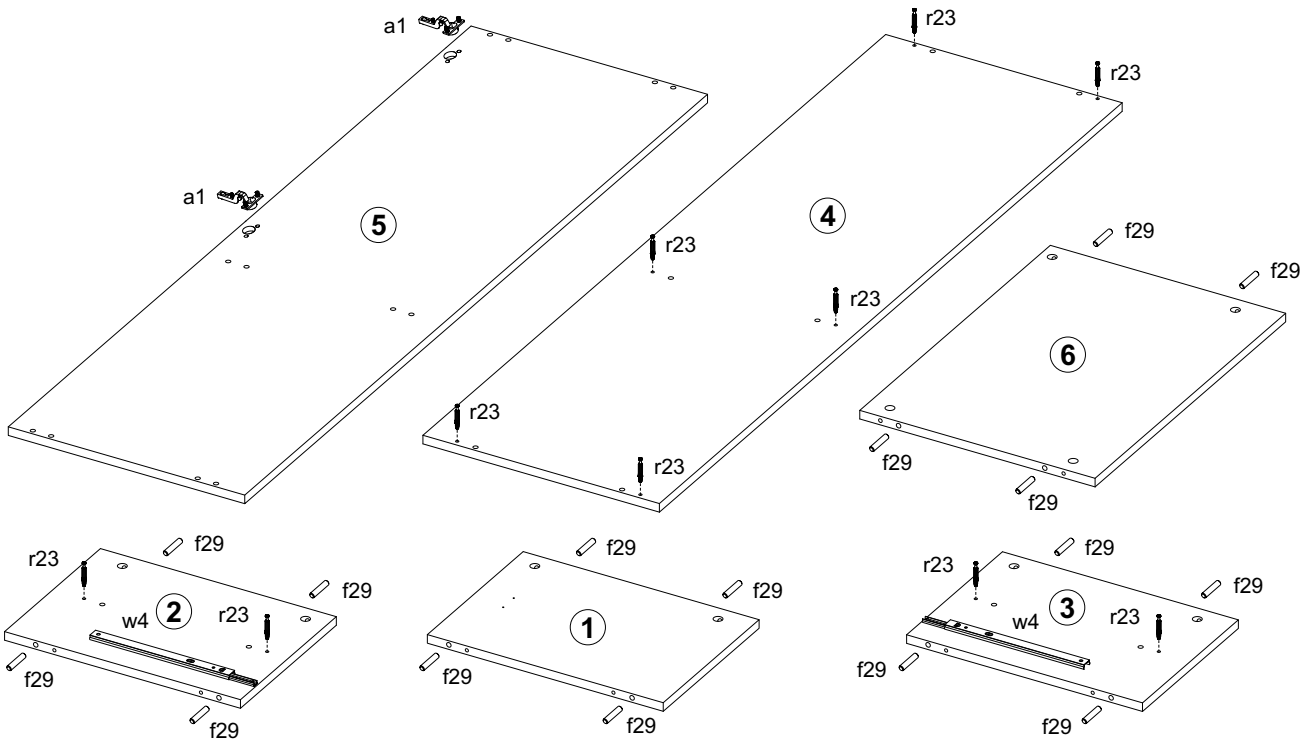
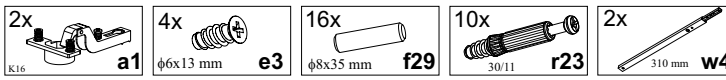

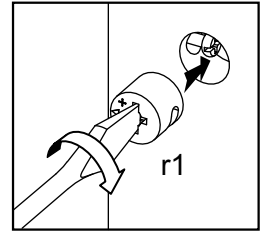
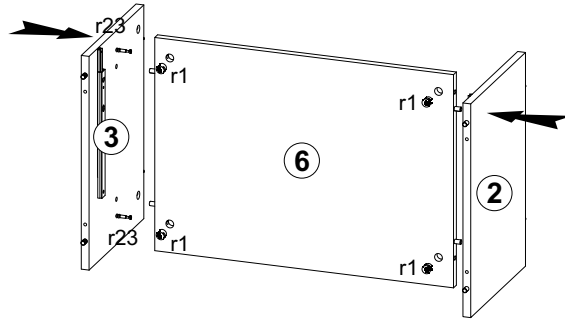
24x $\phi 15 \times 12 \text{ mm}$ #16 r1**3**6x $\phi 7 \times 50 \text{ mm}$ e16x $\phi 15 \times 12 \text{ mm}$ #16 r1



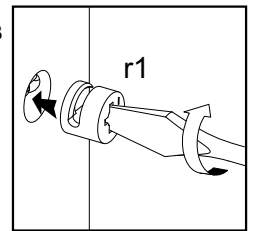
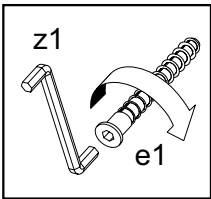
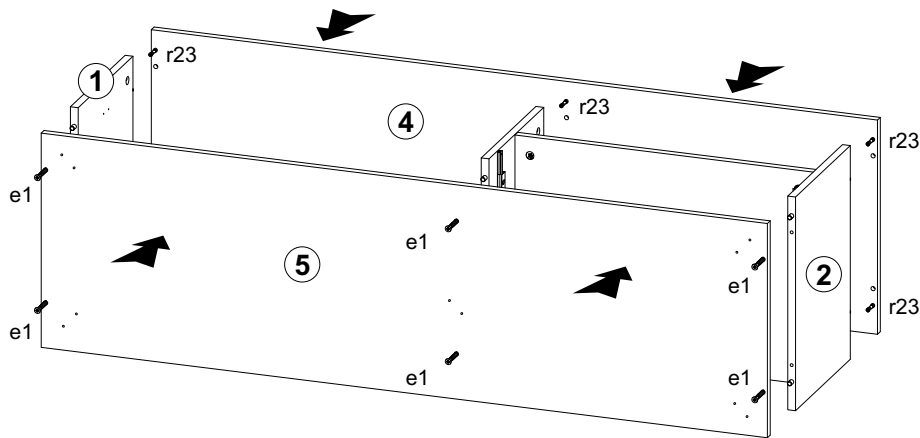

1x z1

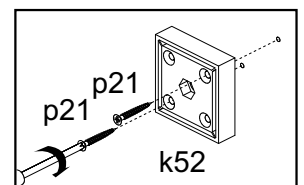
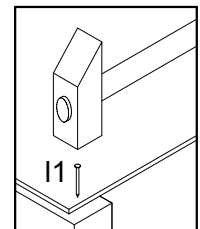
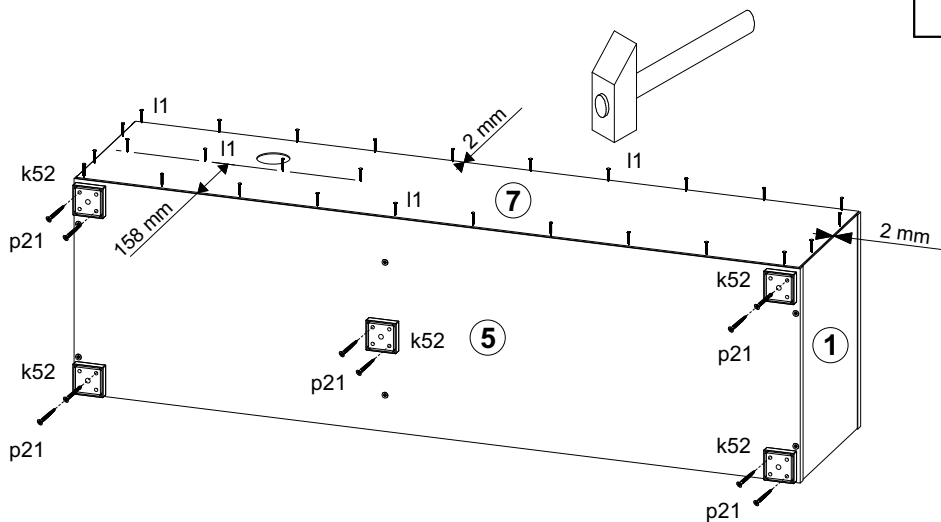
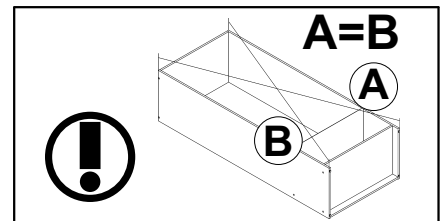
**4**

36x l1

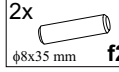
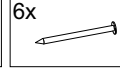

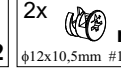
5x $56 \times 56 \times 20 \text{ mm}$ k5210x $\phi 4 \times 30 \text{ mm}$ p21

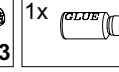
5

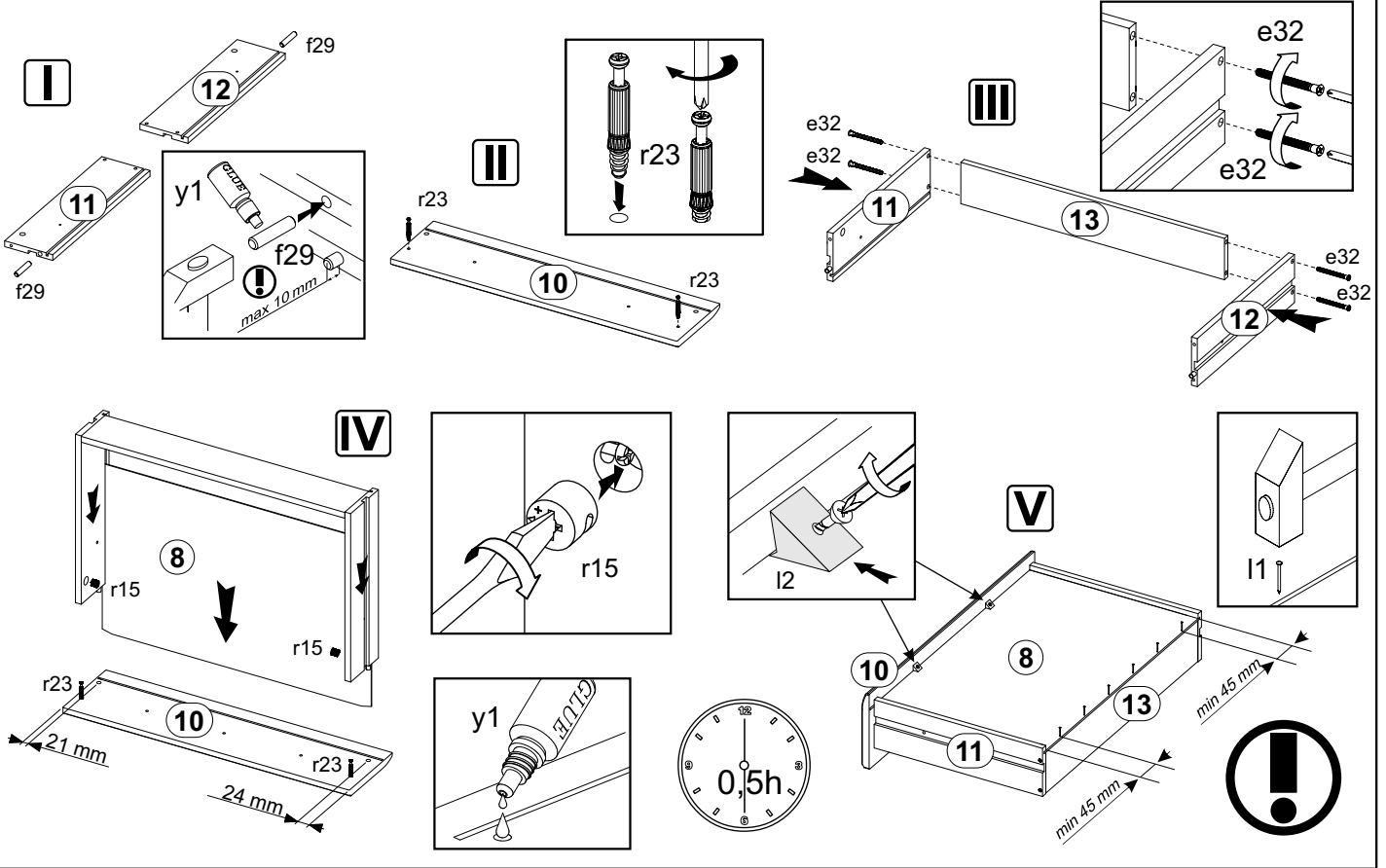
- 4x  $\phi 5 \times 50$ mm **e32**
- 2x  $\phi 8 \times 35$ mm **f29**
- 6x  **l1**
- 2x  **l2**
- 2x  $\phi 12 \times 10,5$ mm #12 **r15**
- 2x  3011 **r23**
- 1x  **y1**

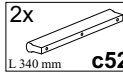

6

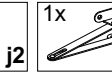
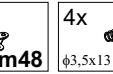
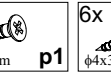
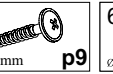
- 2x  L 340 mm **c520**
- 2x  M4x9 mm **j2**
- 1x  **m48**
- 4x  $\phi 3,5 \times 13$ mm **p1**
- 6x  $\phi 4 \times 30$ mm **p9**
- 6x  $\phi 16$ **s2**

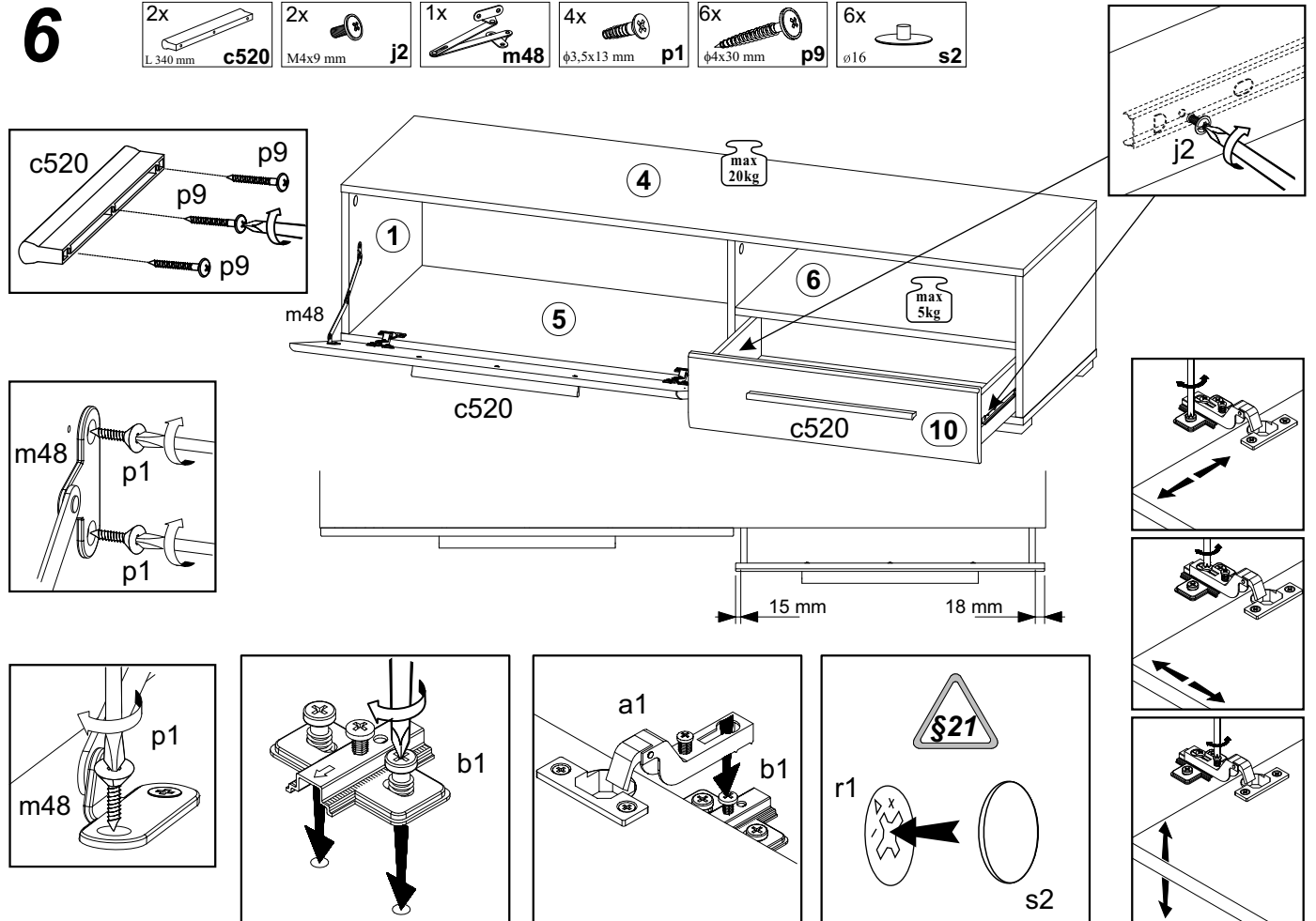



Тумба РТВ права / Тумба РТВ правая

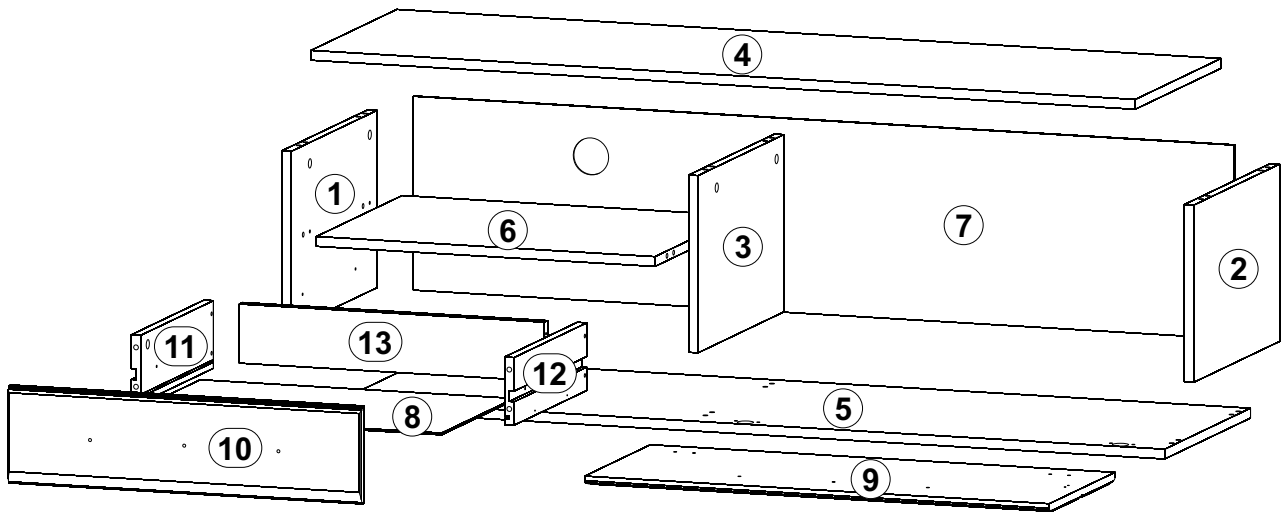

A	B	C	D	
1	PU1-104	288	413	2/5
2	PU1-106	288	413	2/5
3	PU1-105	288	413	2/5
4	PU1-203	1400	413	2/5
5	PU1-221	1400	413	2/5
6	PU1-301	575	413	2/5
7	PU1-907	1394	315	2/5

A	B	C	D	
8	PU1-904	554	378	2/5
9	PU1-020A	792	316	5/5
10	PU1-005A	600	158	5/5
11	PU1-551	375	100	5/5
12	PU1-552	375	100	5/5
13	PU1-553	543	85	3/5



7

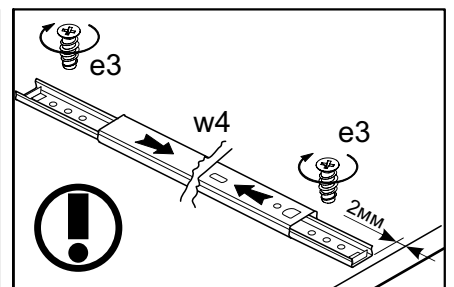
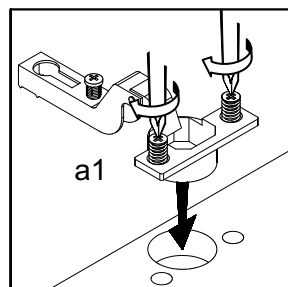
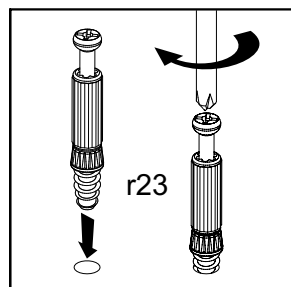
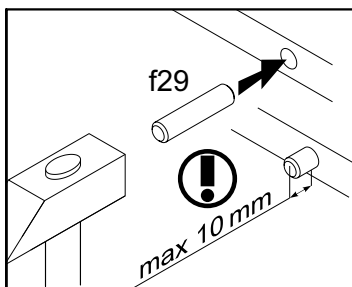
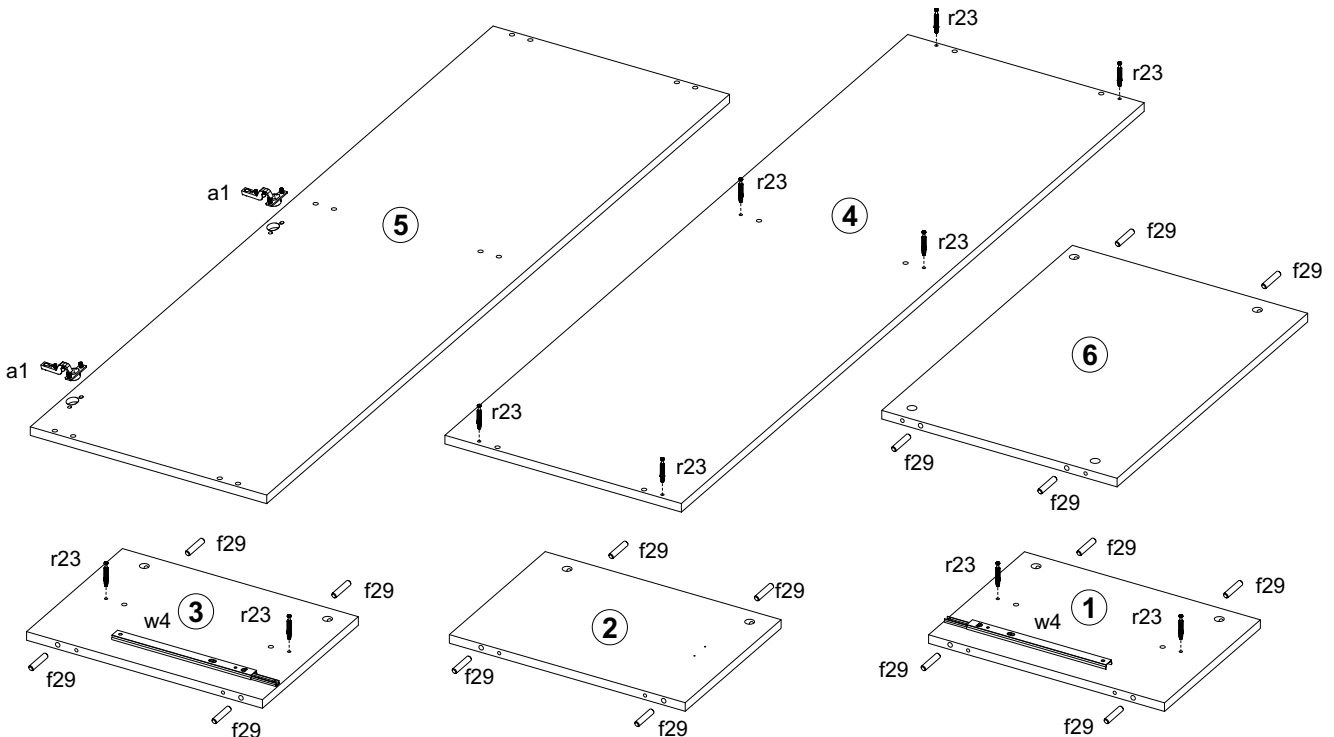
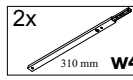
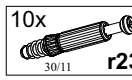
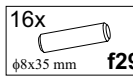
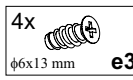
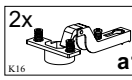

8



4x $\phi 15 \times 12 \text{ mm}$ #16 r1

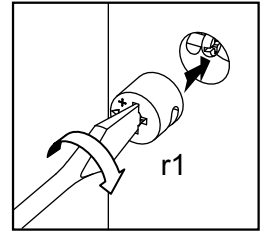
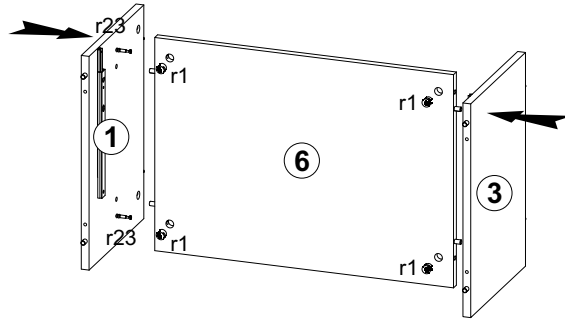

9

6x $\phi 7 \times 50 \text{ mm}$ e1

6x $\phi 15 \times 12 \text{ mm}$ #16 r1

1x z1

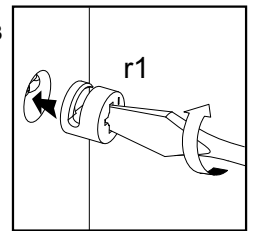
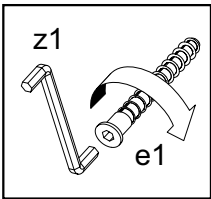
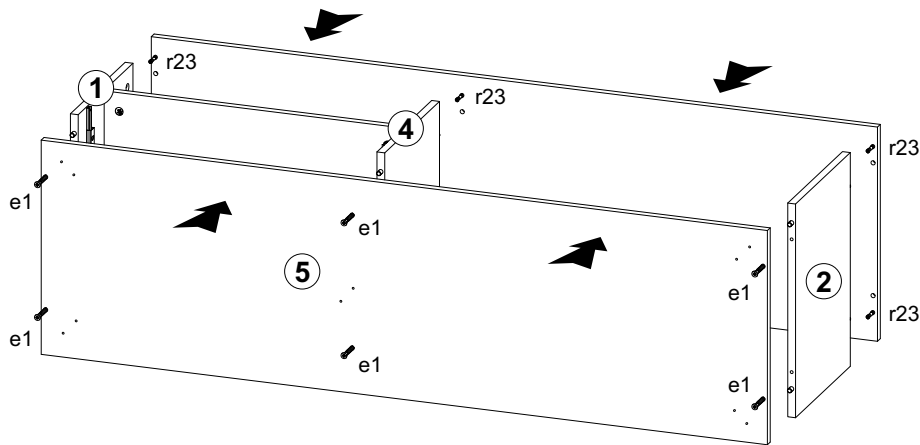

10



36x l1

5x k52 $56 \times 56 \times 20 \text{ mm}$

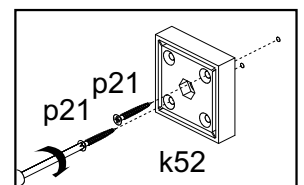
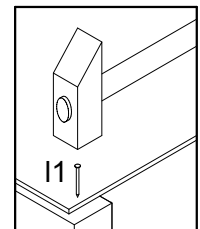
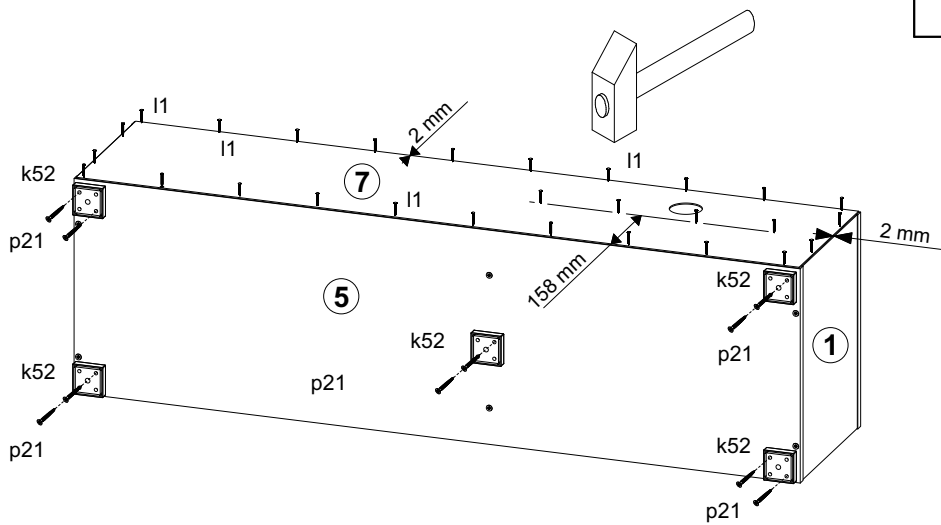
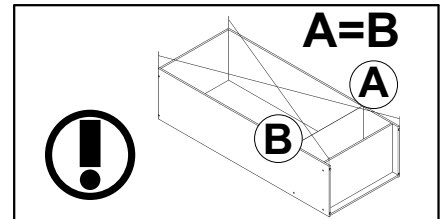
10x $\phi 4 \times 30 \text{ mm}$ p21



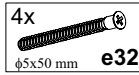
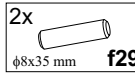
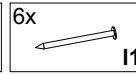
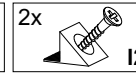

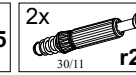
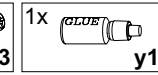
11

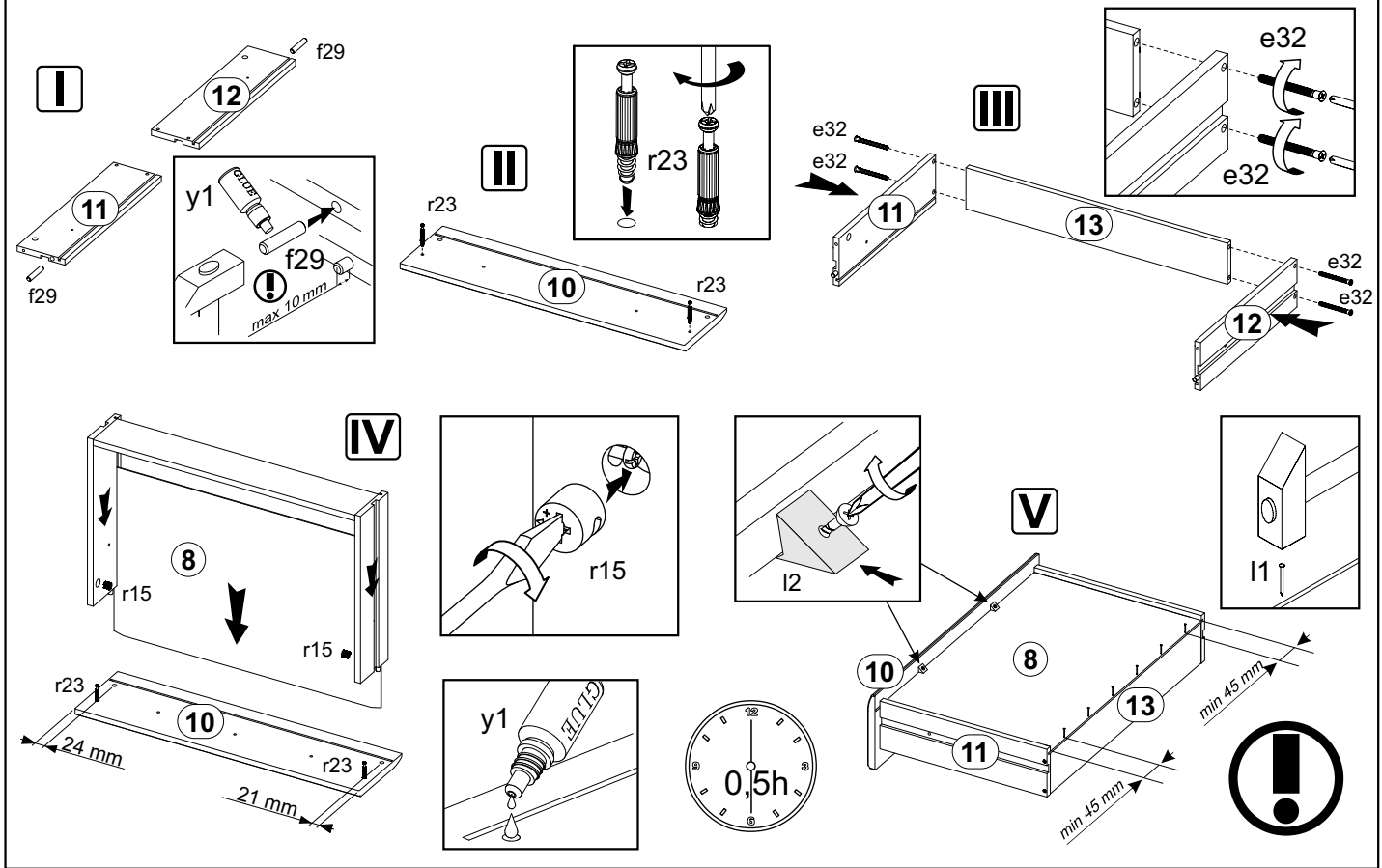
- 4x  **e32**
φ5x50 mm
- 2x  **f29**
φ8x35 mm
- 6x  **l1**
- 2x  **l2**
- 2x  **r15**
φ12x10,5mm #12
- 2x  **r23**
3011
- 1x  **y1**

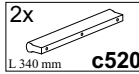
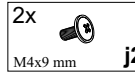
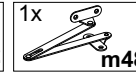

12

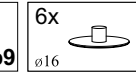
- 2x  **c520**
L 340 mm
- 2x  **j2**
M4x9 mm
- 1x  **m48**
- 4x  **p1**
φ3,5x13 mm
- 6x  **p9**
φ4x30 mm
- 6x  **s2**
φ16

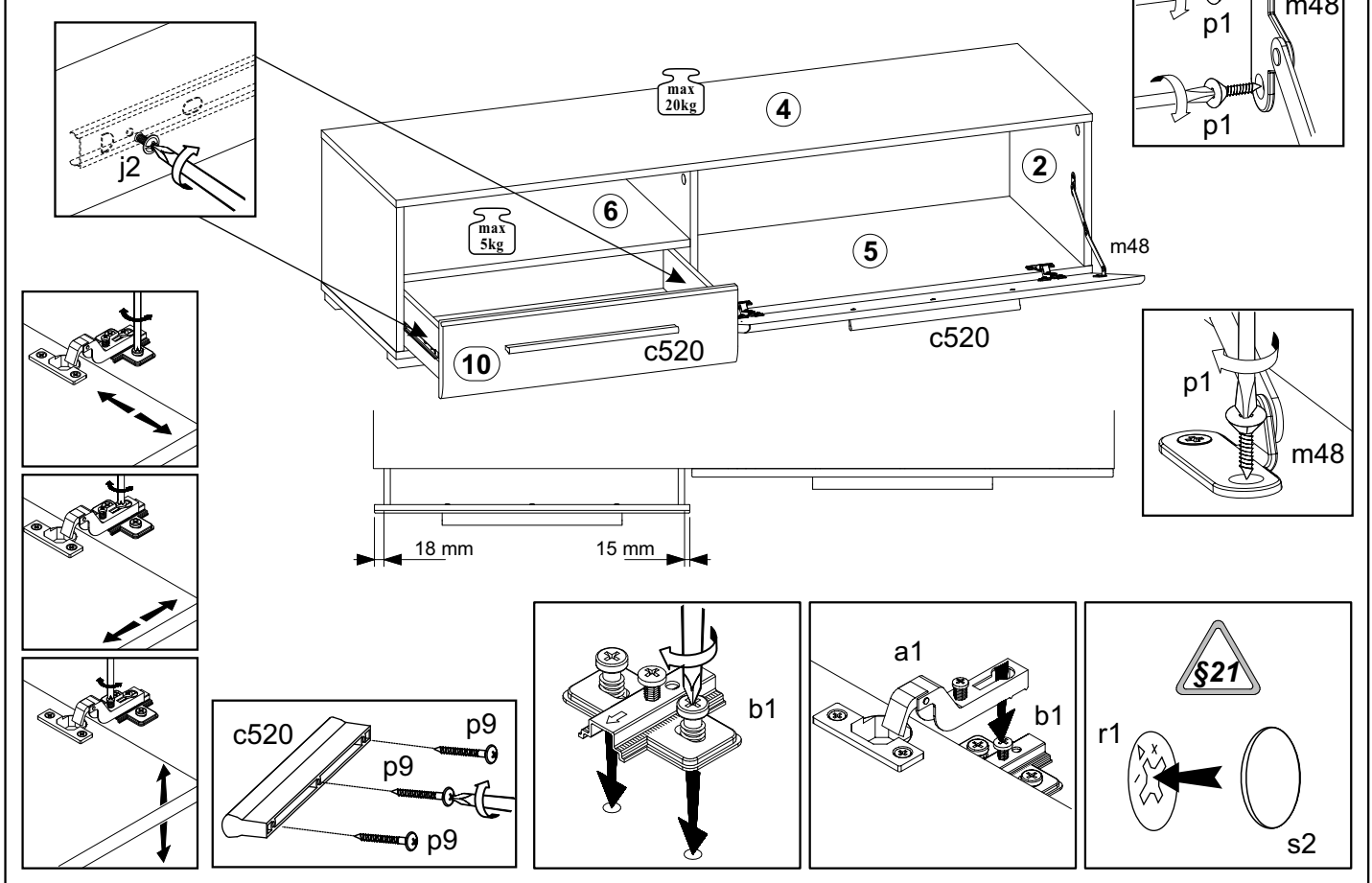



Вітрина навісна ліва / Витрина навесная левая

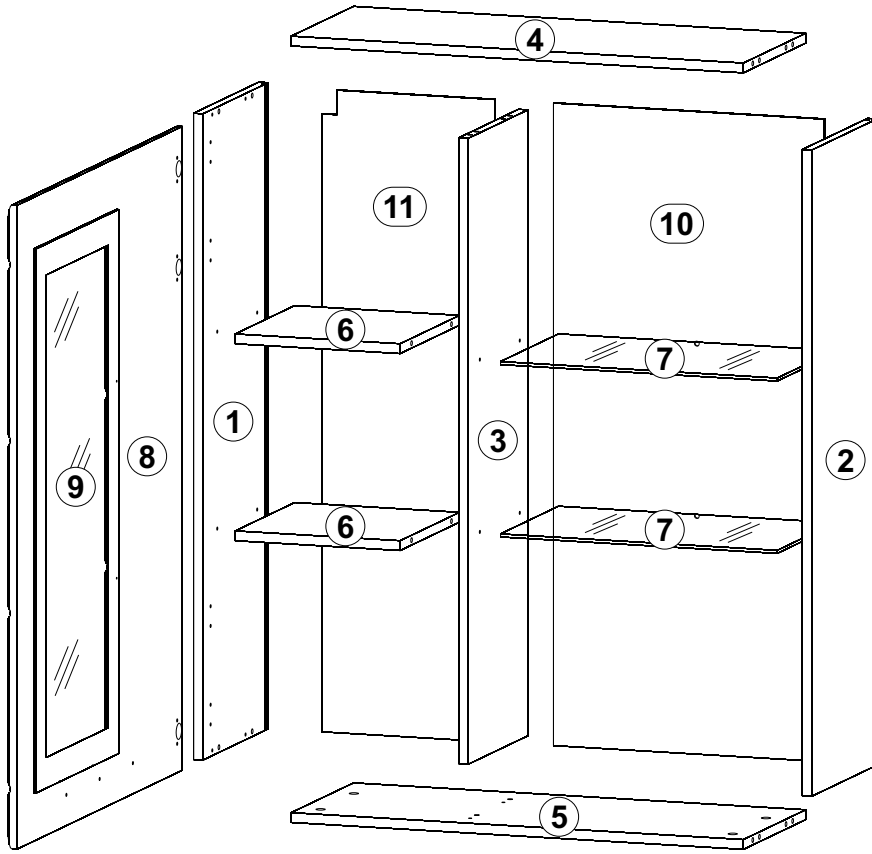

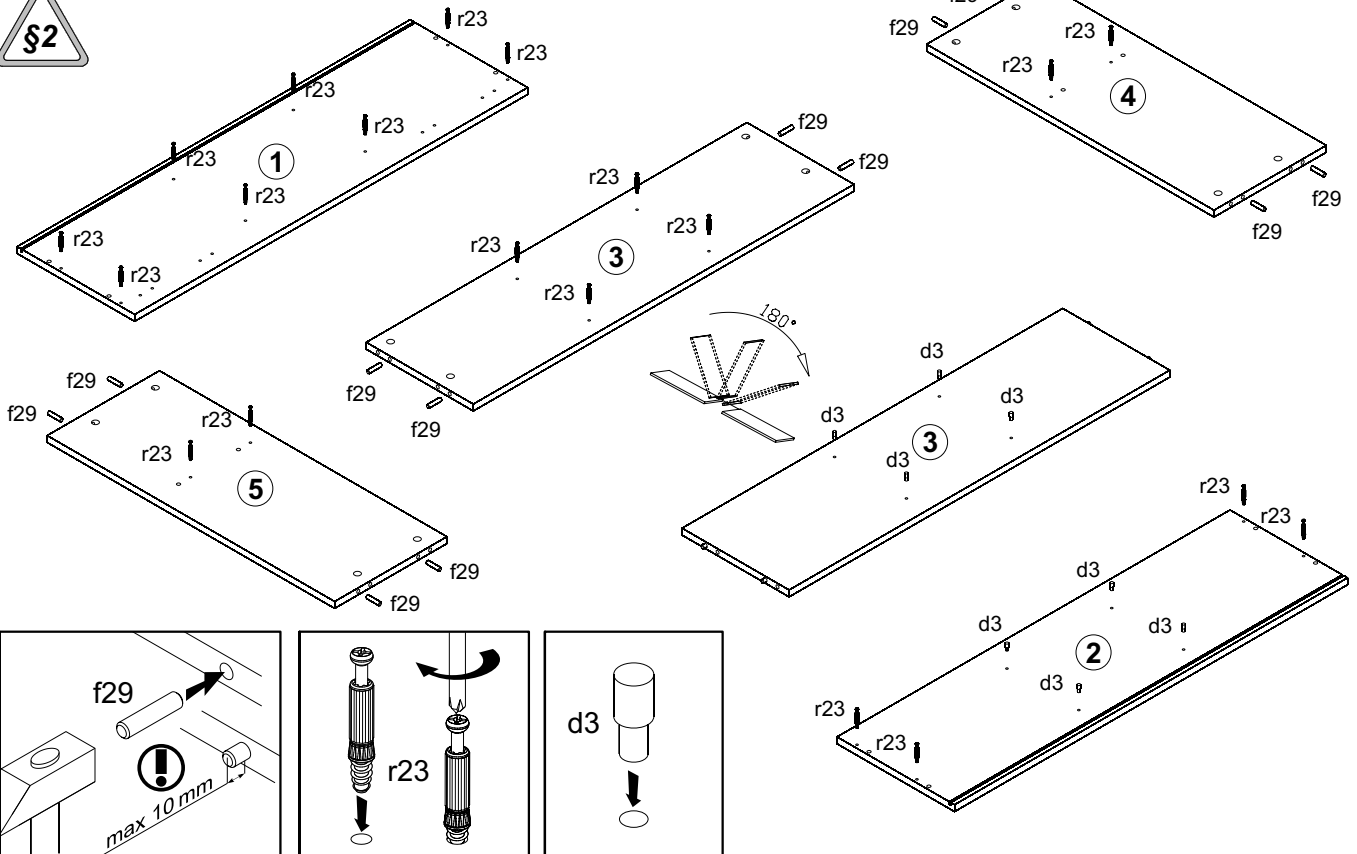
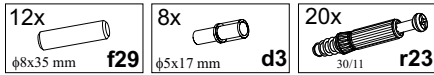

A	B	C	D	
1	PU1-107-01	1050	314	3/5
2	PU1-108-01	1050	314	3/5
3	PU1-109	1017	286	3/5
4	PU1-303	768	300	3/5
5	PU1-302	768	300	3/5
6	PU1-304	280	286	3/5
7	PU1-305	470	279	3/5
8	PU1-002A	1046	796	5/5
9	PU1-501	884	398	5/5
10	PU1-902	1044	485	5/5
11	PU1-903	1044	293	5/5

13

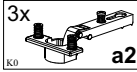
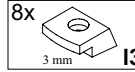
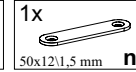
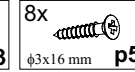

14

- 3x  a2
- 8x  l3 3 mm
- 1x  n3 50x12x1,5 mm
- 8x  p52 $\phi 3 \times 16$ mm
- 2x  p100 $\phi 3 \times 10$ mm

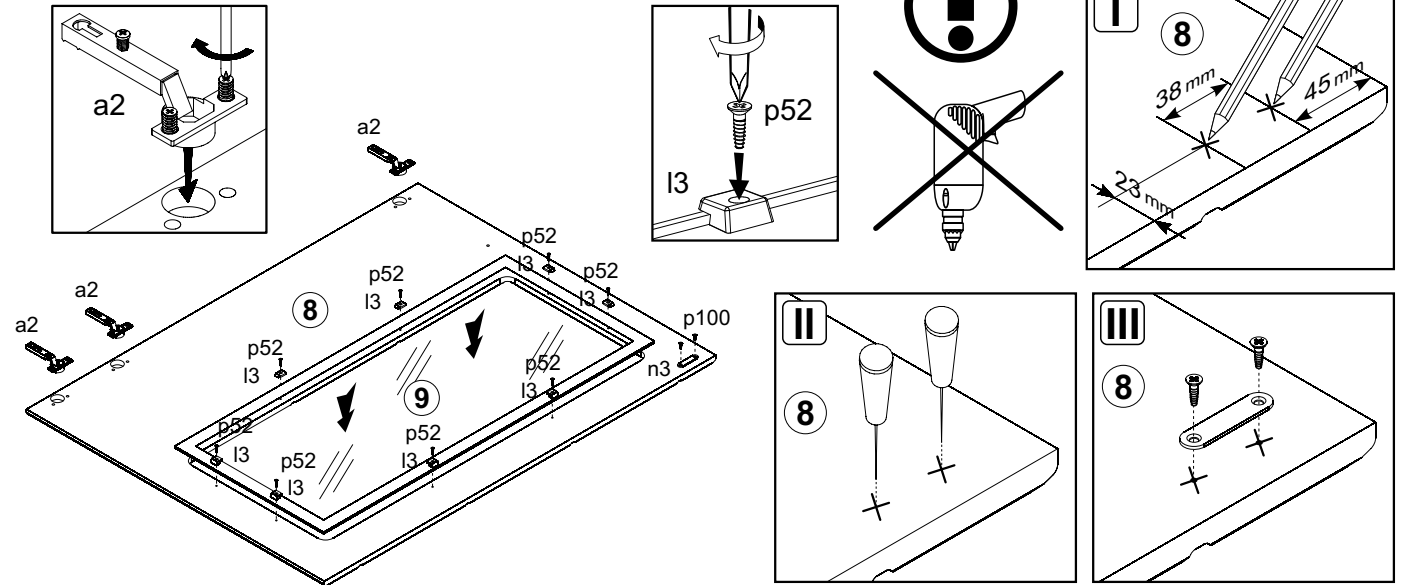

15

- 8x  r1 $\phi 15 \times 12$ mm #16

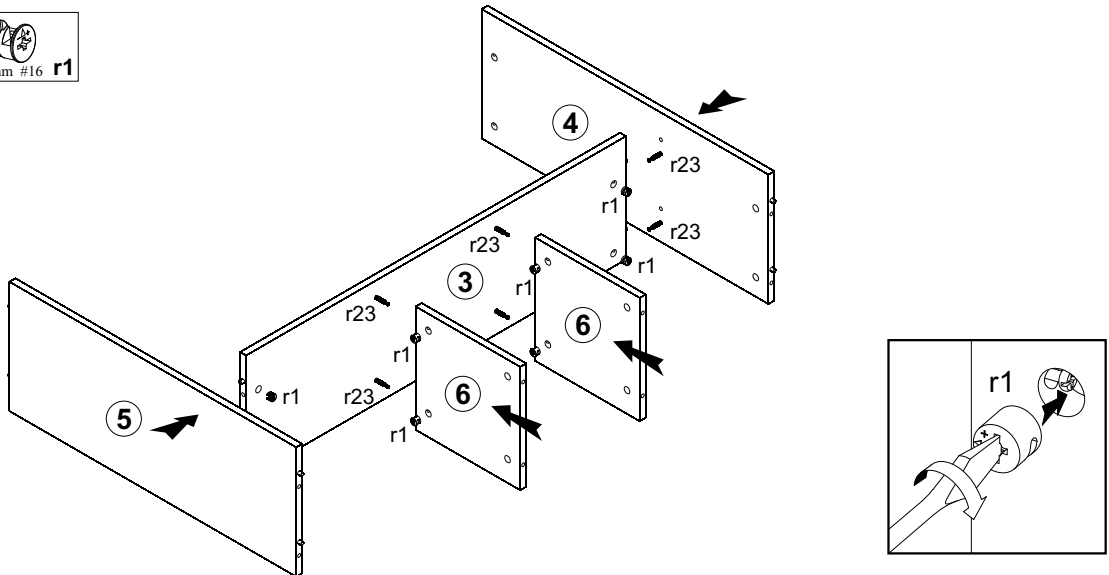

16

- 12x  r1 $\phi 15 \times 12$ mm #16

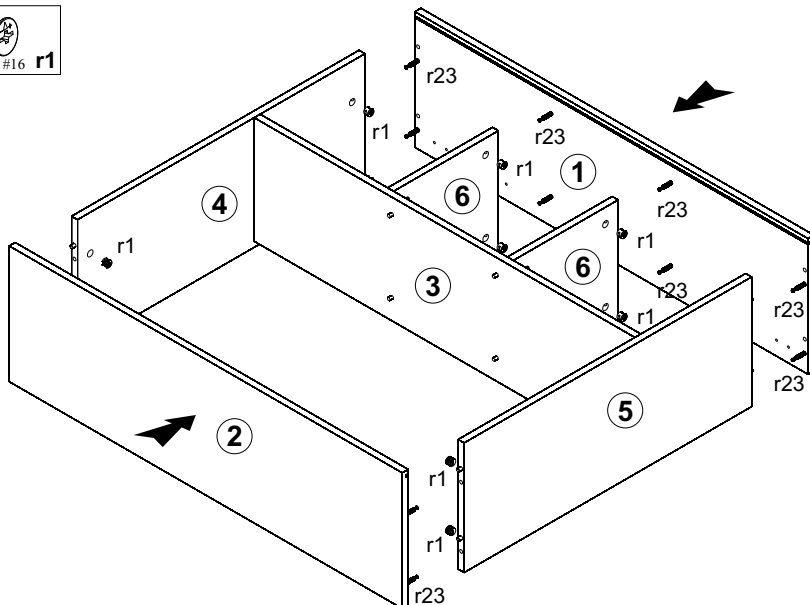

17

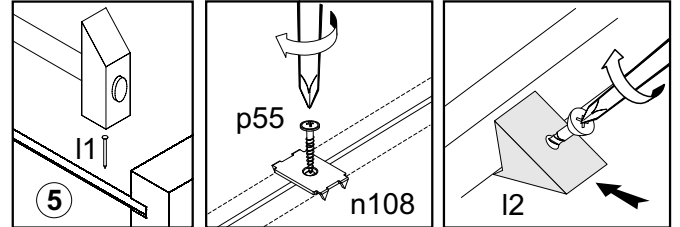
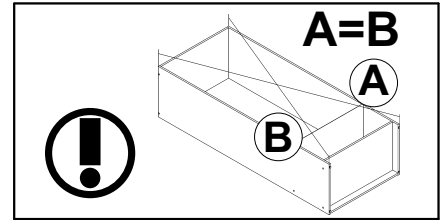
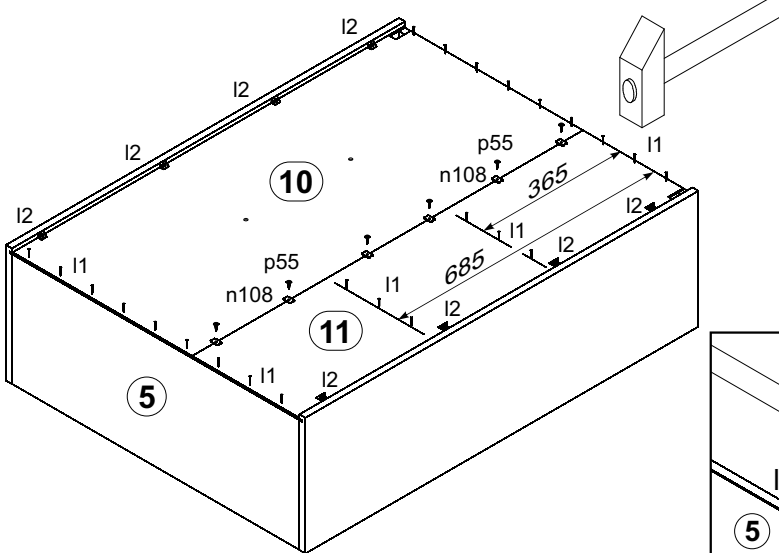
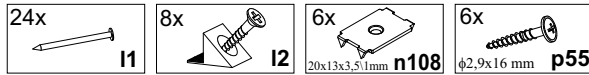

18

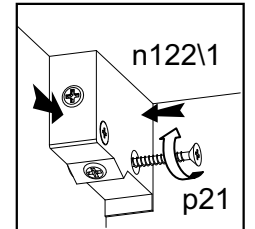
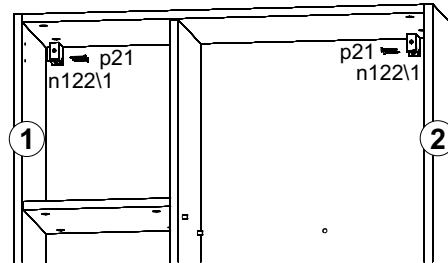
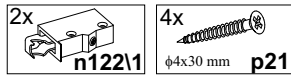

19

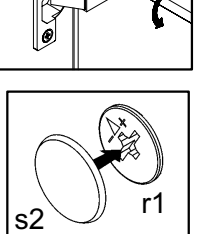
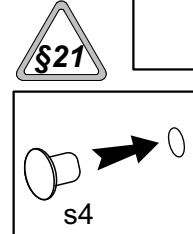
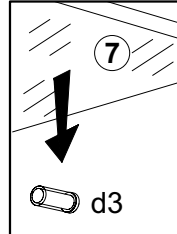
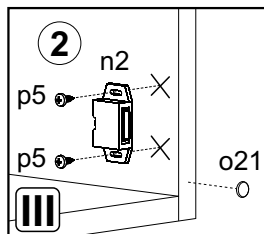
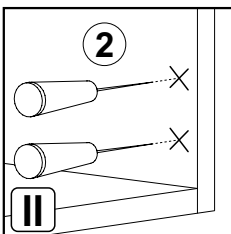
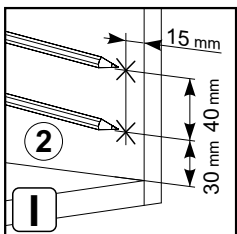
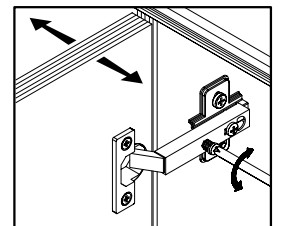
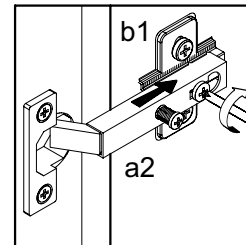
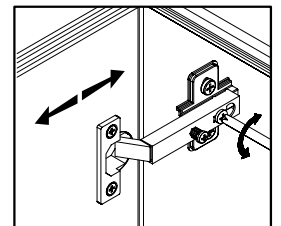
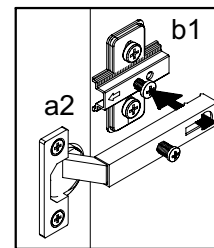
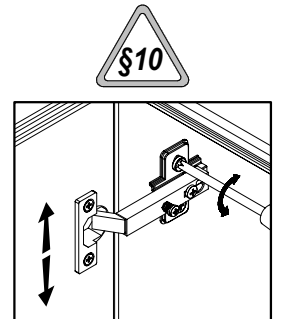
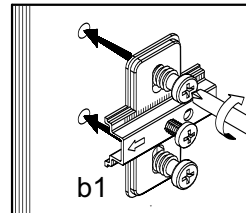
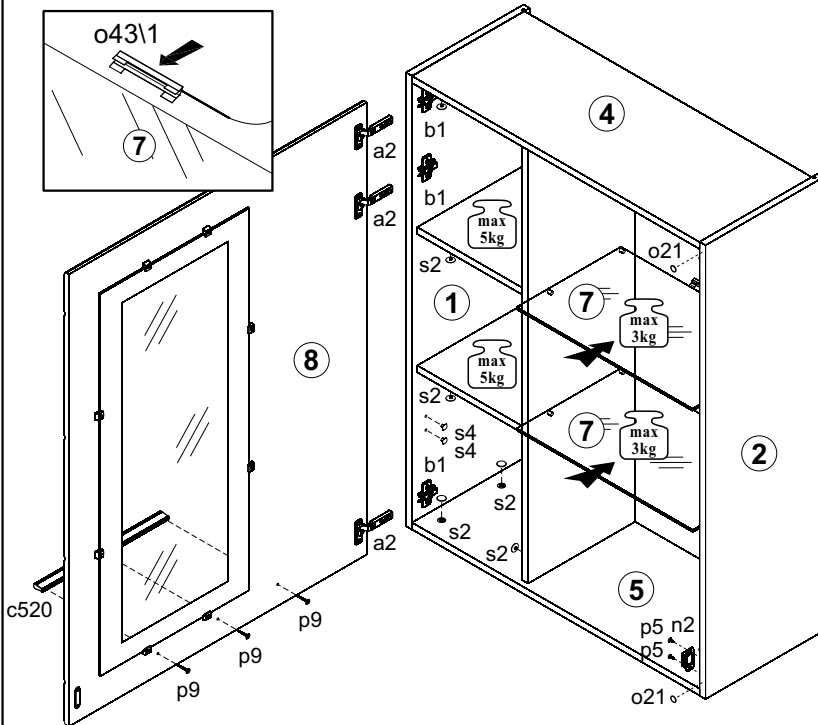

IV

Вітрина навесна права / Витрина навесная правая

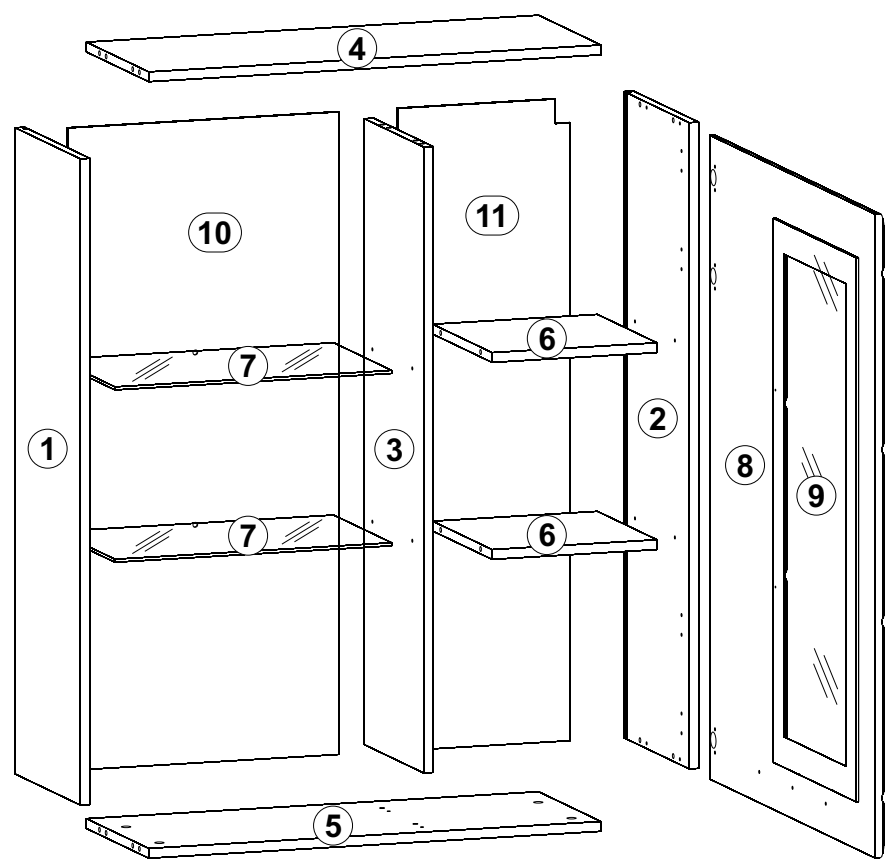

A	B	C	D	
1	PU1-108-01	1050	314	4/5
2	PU1-107-01	1050	314	4/5
3	PU1-109	1017	286	4/5
4	PU1-302	768	300	4/5
5	PU1-303	768	300	4/5
6	PU1-304	280	286	4/5
7	PU1-305	470	279	4/5
8	PU1-007A	1046	796	5/5
9	PU1-501	884	398	5/5
10	PU1-905	1044	485	5/5
11	PU1-906	1044	293	5/5

20

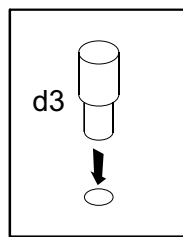
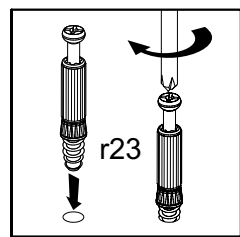
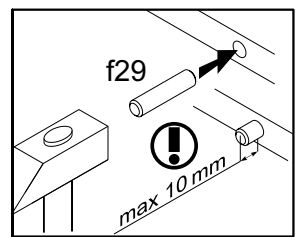
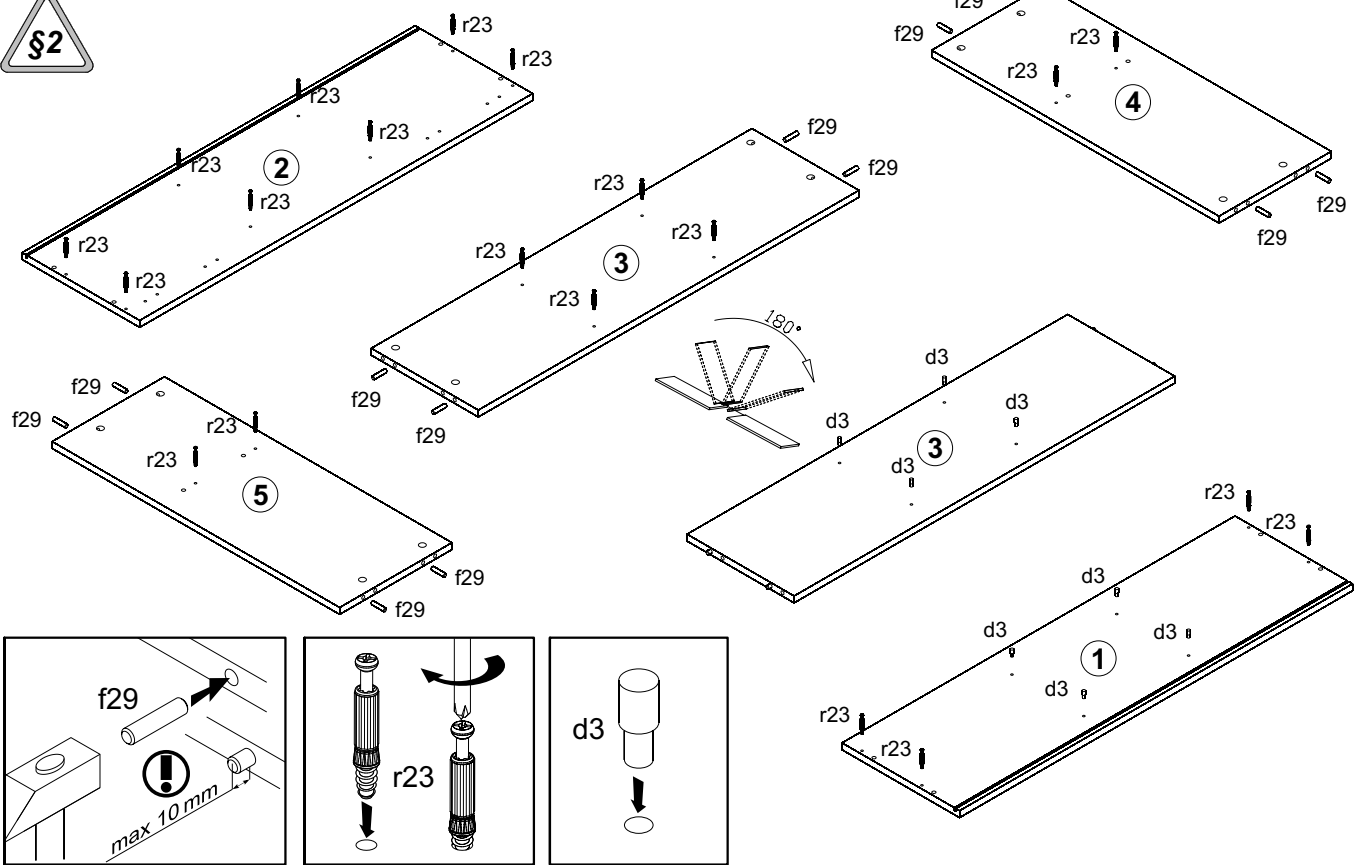
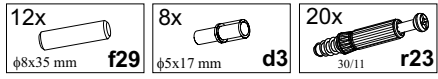

21

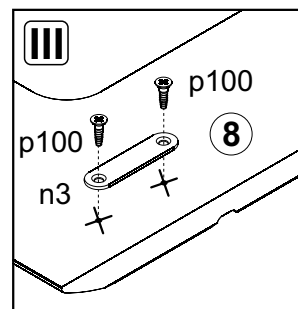
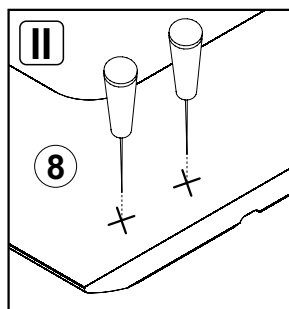
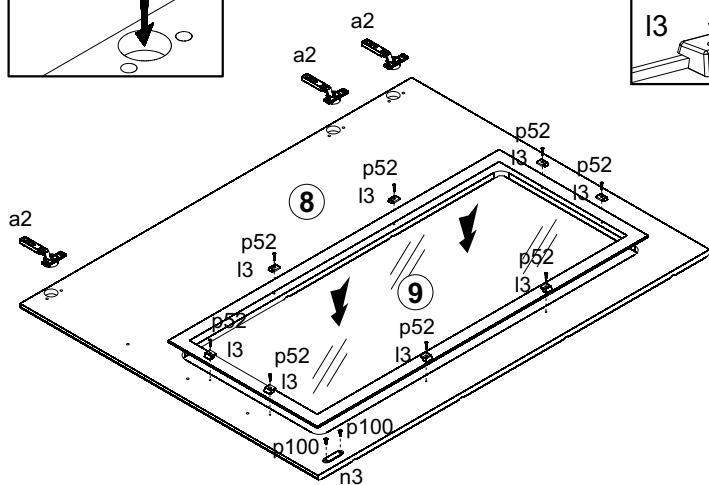
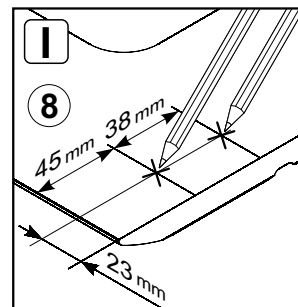
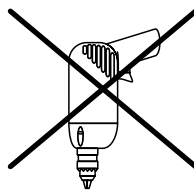
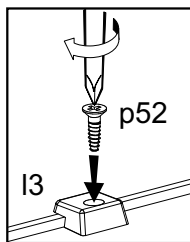
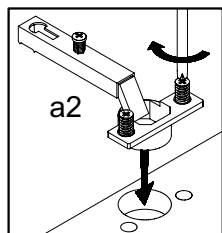
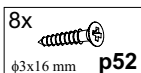
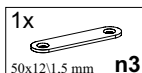
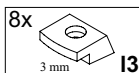
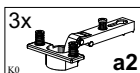

22

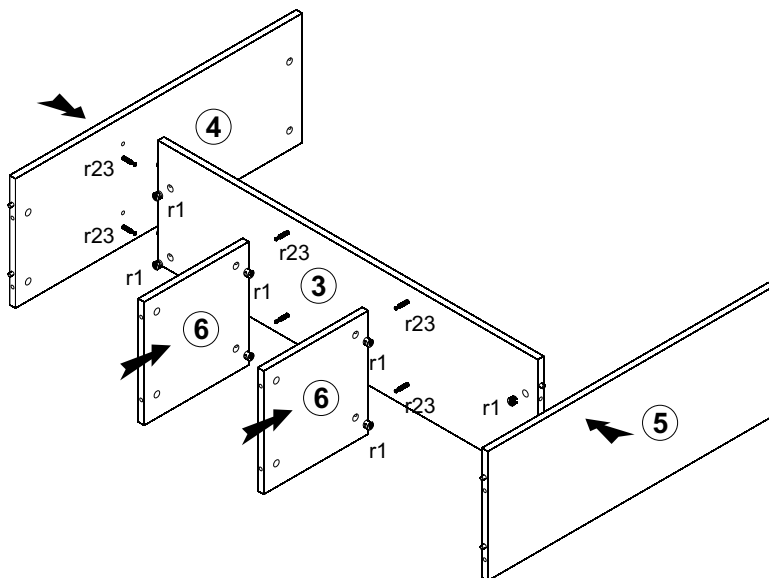
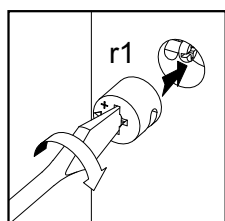

23

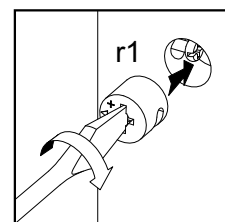
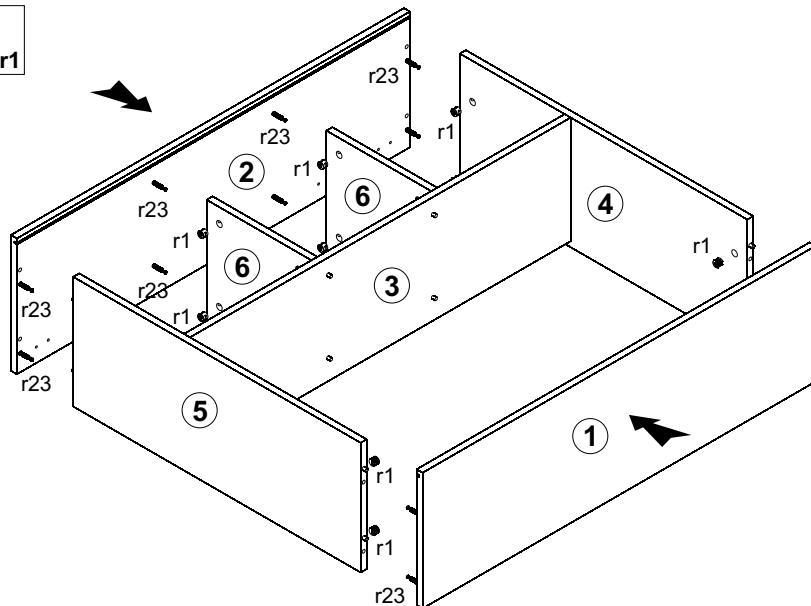
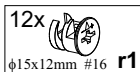

24

- 24x I1
- 8x I2
- 6x 20x13x3.51mm n108
- 6x $\phi 2.9 \times 16$ mm p55

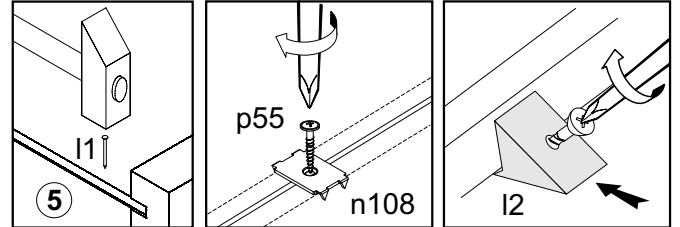
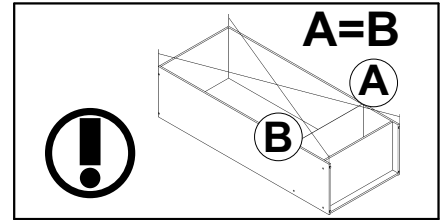
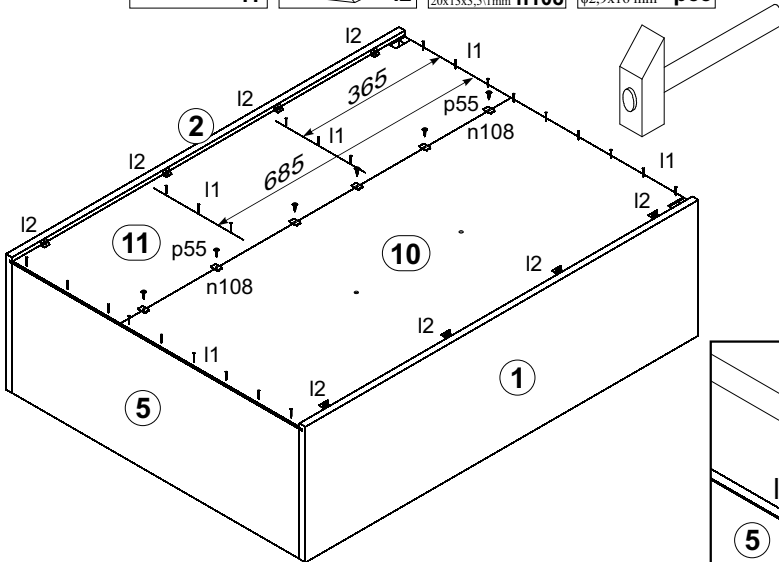

25

- 2x n122\1
- 4x $\phi 4 \times 30$ mm p21

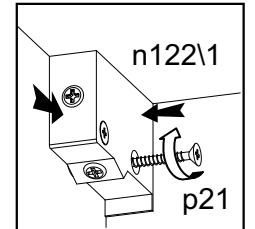
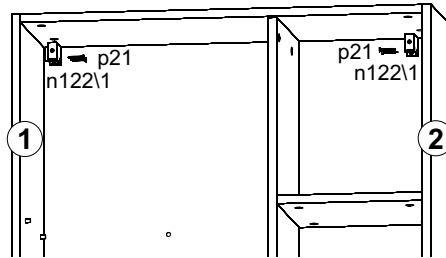

26

- 3x b1
- 1x L 340 mm c520
- 1x n2
- 2x $\phi 8 \times 1.8$ mm o21
- 2x o43\1
- 2x $\phi 3.5 \times 13$ mm p5
- 3x $\phi 4 \times 30$ mm p9
- 20x $\phi 16$ s2
- 2x $\phi 5$ s4

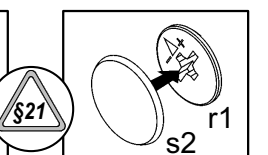
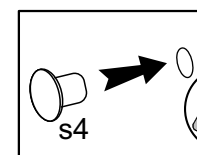
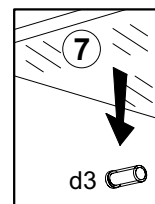
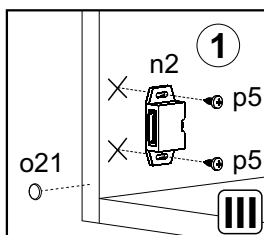
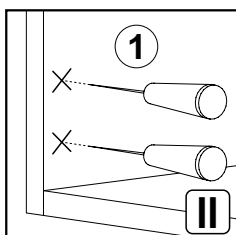
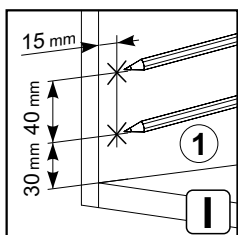
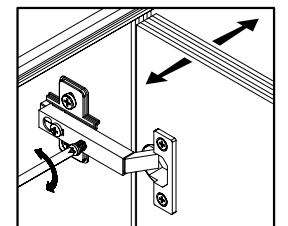
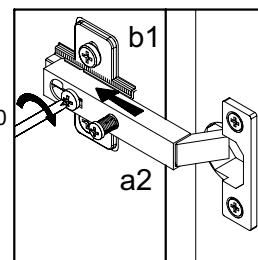
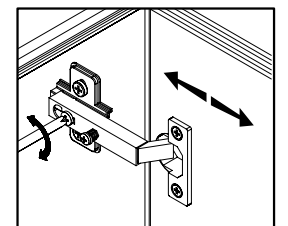
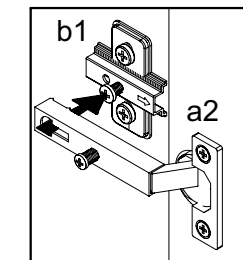
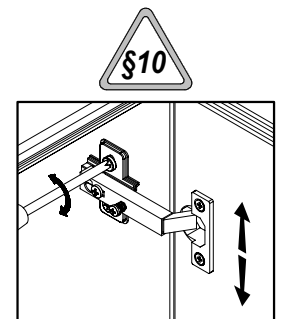
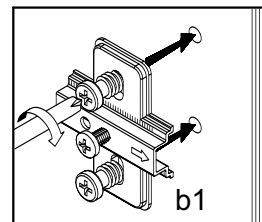
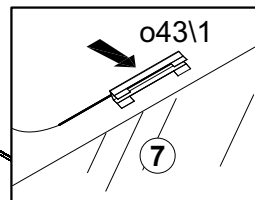
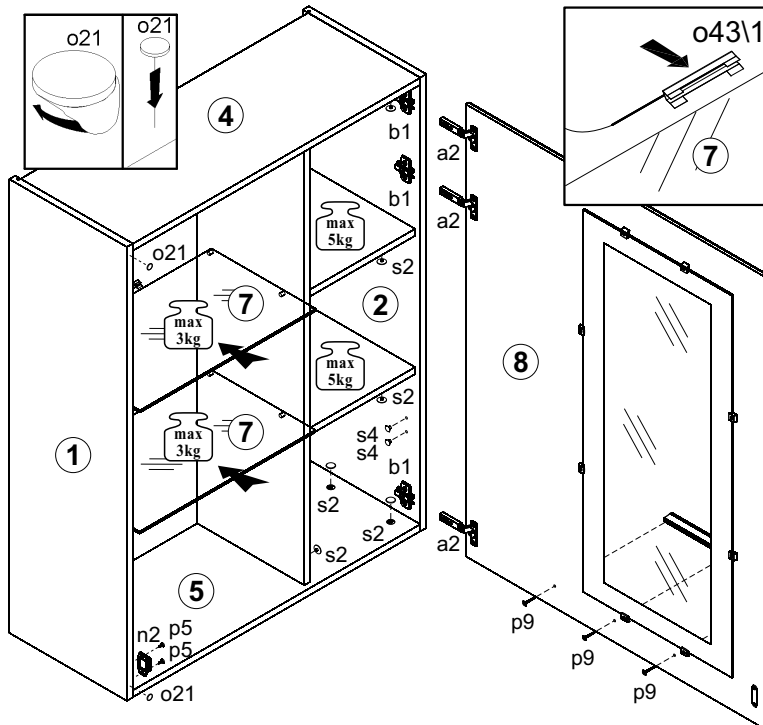

V Полиця / Полка

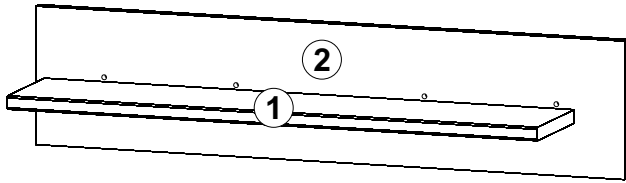

A	B	C	D
1	PU1-306	900	180
2	PU1-401	225	1000



27

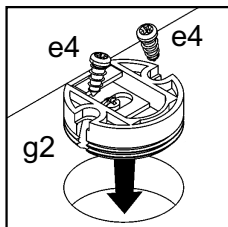
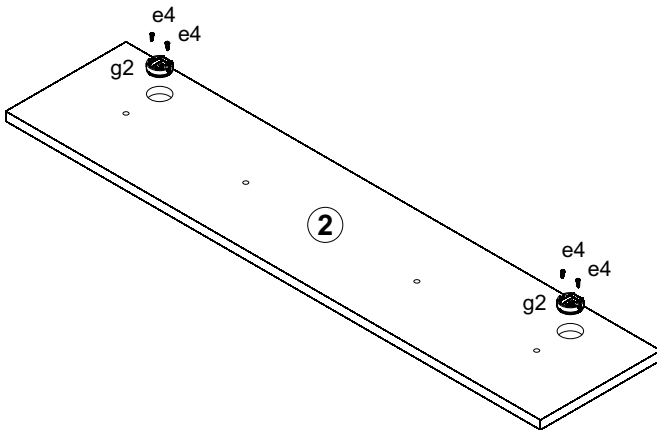
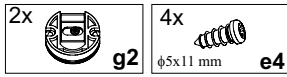

28

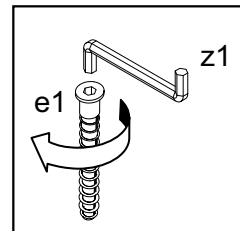
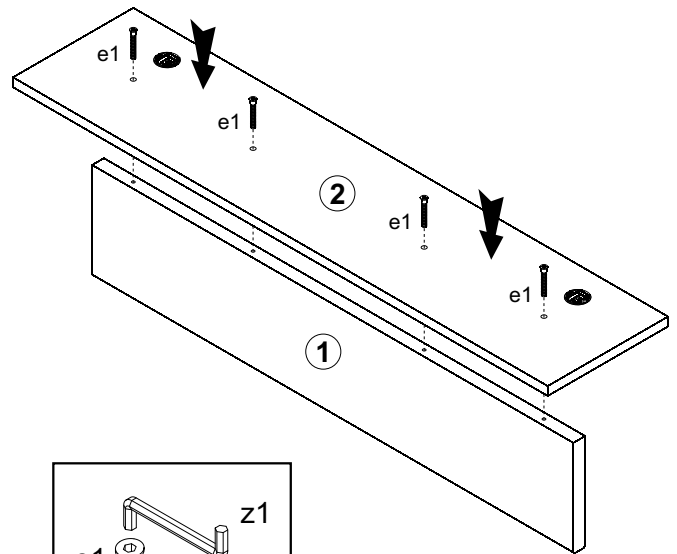
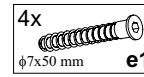

29

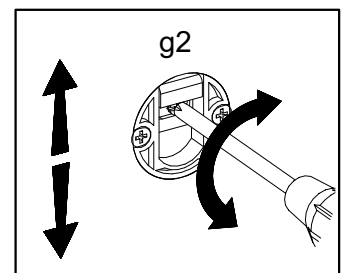
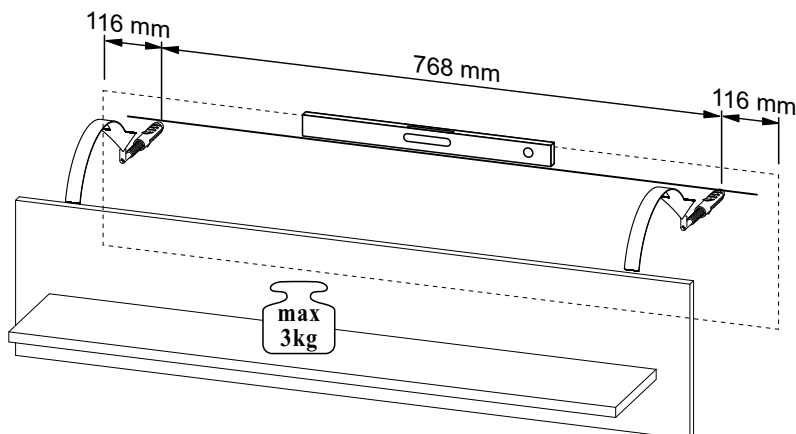
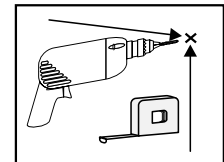
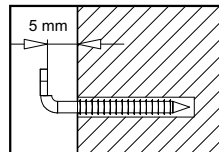
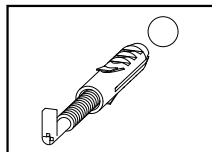
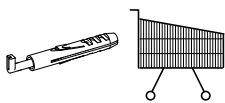

30

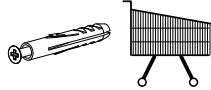
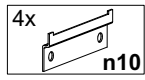

25 mm

64 mm

64 mm

25 mm

